



Casse di ventilazione omologate 400°C/2h, costruite in lamiera di acciaio zincato, doppia parete (tipo sandwich) con isolamento acustico ignifugo (M0) in fibra di vetro sp. 17 mm, ventilatore centrifugo con girante a pale curve rovesce in lamiera zincata, equilibrata dinamicamente. Motore direttamente accoppiato per funzionamento in continuo fino ad una temperatura di +120°C, IP55, classe F, con protezione termica e scatola morsettiera remota.

Motori

A 4 poli.
Regolabili per variazione di tensione.
Modelli trifase regolabili con variatore di frequenza.

Tensione di alimentazione:

Monofase 230V-50Hz (CHVB)

Trifase 400V-50Hz (CVHT)

(vedere schema caratteristiche tecniche)

Su richiesta:

Motori trifase 230/400V-50Hz.

Altri dati

Adatti per funzionamento a 120°C in continuo.



Versatilità di installazione



Omologazione secondo la norma EN12101-3.
Certificazione 0370-CPD-0666

Parcheggi

Cucine

Configuración versátil

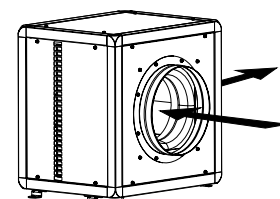
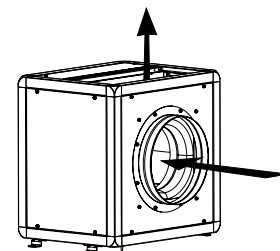
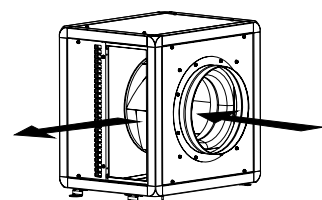

Girante centrifuga a pale rovesce

Girante equilibrata (ISO 1940) per ridurre il rumore ed evitare le vibrazioni. Trattata con verniciatura antiaderente per evitare l'accumulo di sporcizia.



Robustezza

Rifiniture di qualità con angolari proporzionati che conferiscono grande robustezza.



Facile installazione

I piedini di supporto inclusi facilitano l'installazione.

CARATTERISTICHE TECNICHE

Importante: verificare che le caratteristiche elettriche (tensione, frequenza, assorbimento, ecc..) siano compatibili con quelle dell'installazione.

Modello	Velocità (r.p.m.)	Potenza assorbita massima (W)	Intensità assorbita massima (A)	Portata aria massima (m³/h)	Livello pressione sonora* (dB(A) a 1,5 m)	Peso (kg)	Regolatore di tensione opzionale
MONOFASE							
CHVB/4-3000/315	1390	305	1,45	2.670	58	46	REB-2,5 N
CHVB/4-4000/355	1315	530	2,3	4.300	64	75	REB-2,5 N
CHVB/4-6000/400	1370	1060	5,05	6.480	70	90	REB-10
TRIFASE							
CHVT/4-3000/315	1410	320	0,86	2.770	58	46	RMT-1,5
CHVT/4-4000/355	1420	920	1,8	4.310	64	75	RMT-2,5
CHVT/4-6000/400	1295	912	1,95	6.560	70	90	RMT-2,5

* Regolatori trifase (RMT) consigliato a 400 V.

CARATTERISTICHE ACUSTICHE

Spettro di potenza sonora dB(A) per banda di frequenza (Hz):

Posizione punto di lavoro: LP: Bassa pressione

MP: Media pressione

HP: Alta pressione

4-3000/315		63	125	250	500	1000	2000	4000	8000	LwA
Aspirazione	LP	44	70	67	67	69	68	63	60	76
	MP	44	64	69	60	61	60	57	52	72
	HP	44	62	64	71	71	67	63	55	76
Scarico	LP	42	72	67	68	69	69	63	60	77
	MP	40	66	64	66	68	66	61	54	73
	HP	39	62	63	64	67	66	61	53	72
Irradiato	LP	37	63	60	55	55	55	54	48	66
	MP	37	57	62	48	47	47	48	40	64
	HP	37	55	57	59	57	54	54	43	64

4-6000/400		63	125	250	500	1000	2000	4000	8000	LwA
Aspirazione	LP	51	70	70	73	83	78	71	74	85
	MP	50	64	68	73	75	71	69	65	79
	HP	55	68	71	75	79	75	71	64	82
Scarico	LP	53	73	73	75	84	82	73	75	87
	MP	49	68	68	70	72	69	70	66	78
	HP	58	70	72	72	72	70	70	63	79
Irradiato	LP	47	59	58	60	64	58	53	55	68
	MP	46	53	56	60	56	51	51	46	64
	HP	51	57	59	62	60	55	53	45	67

4-4000/355		63	125	250	500	1000	2000	4000	8000	LwA
Aspirazione	LP	51	69	71	70	72	71	69	75	80
	MP	50	67	69	70	72	67	67	69	78
	HP	51	67	67	72	76	71	68	63	79
Scarico	LP	50	74	73	73	72	72	69	66	80
	MP	47	74	70	70	70	68	64	60	78
	HP	48	65	66	66	67	65	63	56	73
Irradiato	LP	46	65	63	58	56	54	56	58	69
	MP	45	63	61	58	56	50	54	52	67
	HP	46	63	59	60	60	54	55	46	67

CURVE CARATTERISTICHE

- q_v = Portata in m^3/h e m^3/s .
- p_{sf} = Pressione statica mmcda e Pa.
- Aria secca normale a $20^\circ C$ e 760 mmHg.
- Prove eseguite secondo le norme ISO 5801 e AMCA 210-99.
- Valori di pressione sonora (L_p dB(A)) sono misurati a $1,5$ m (in aspirazione, in nero; nella scarica, in blu).

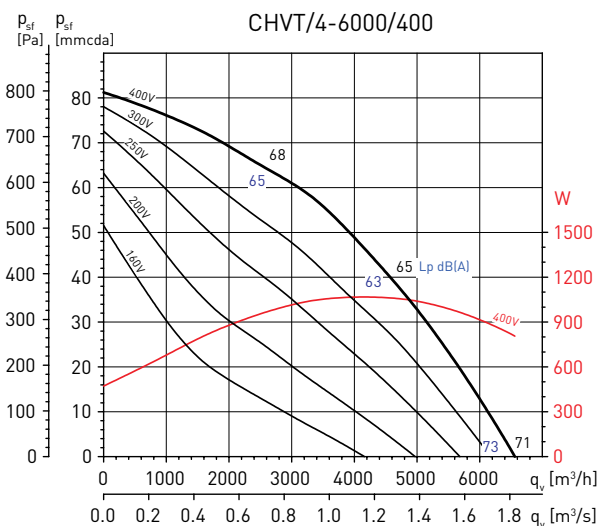
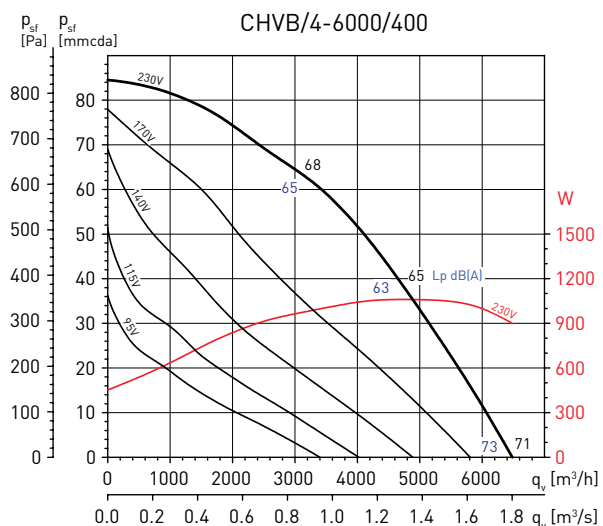
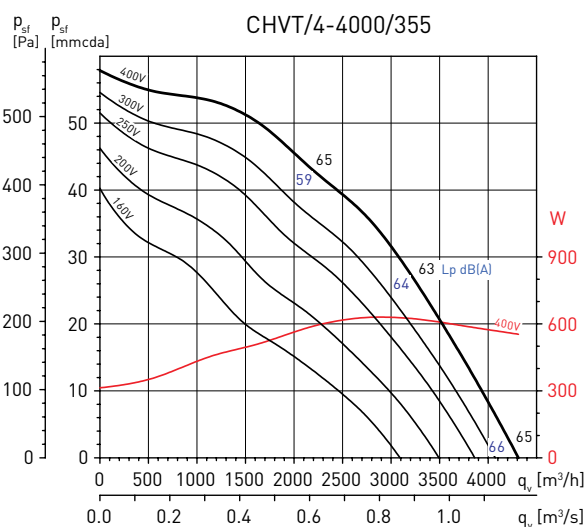
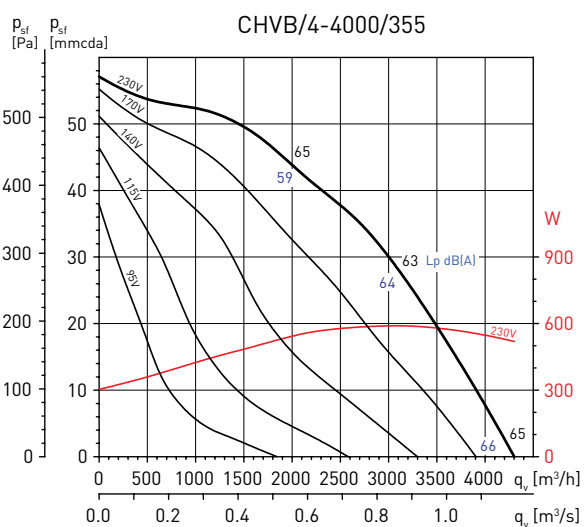
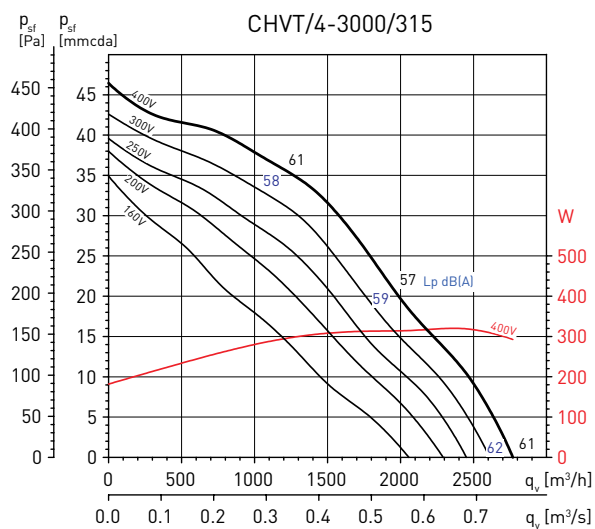
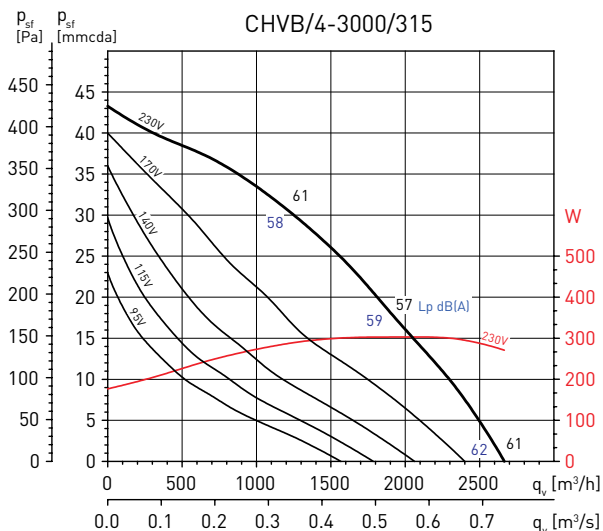

DIMENSIONI (mm)

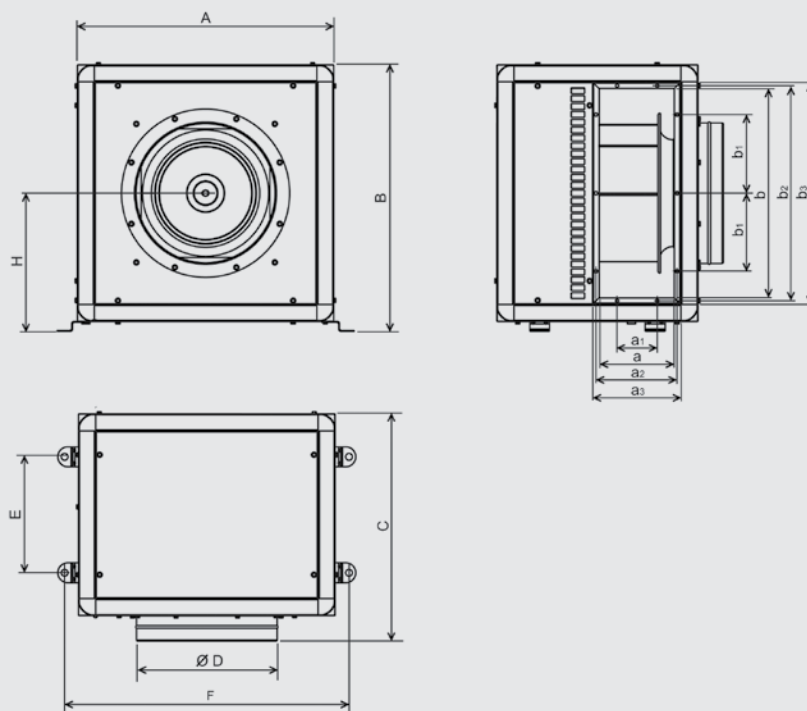

Modello	A	B	C	D	E	F	H	a	a1	a2	a3	b	b1	b2	b3
CHVB/4-3000/315	548	573	527	315	247	618	299	148	110	160	182	429	154	441	462
CHVB/4-4000/355	648	673	572	355	292	718	349	187	106	199	221	529	187	541	562
CHVB/4-6000/400	798	823	572	400	292	858	499	196	115	208	230	679	237	691	712
CHVT/4-3000/315	548	573	527	315	247	618	299	148	110	160	182	429	154	441	462
CHVT/4-4000/355	648	673	572	355	292	718	349	187	106	199	221	529	187	541	562
CHVT/4-6000/400	798	823	572	400	292	858	499	196	115	208	230	679	237	691	712

ACCESSORI DI MONTAGGIO



FD
Flangia di accoppiamento circolare
Da installare alla mandata.

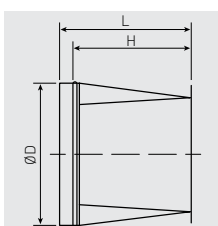

Modello	Ø D	L	H
FD-3000	315	450	400
FD-4000	355	450	400
FD-6000	400	450	400



ACOPEL F400 N
Giunto flessibile circolare
Per funzionamento in emergenza a 400°C/2h.

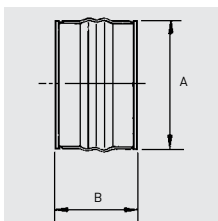

Modello	ØA (mm)	B (mm)
ACOPEL F400-315/160 N	315	160
ACOPEL F400-355/160 N	355	160
ACOPEL F400-400/160 N	400	160



ACOP RECT F400
Giunto elastico rettangolare
Da installare alla mandata. Evita la trasmissione delle vibrazioni. Per funzionamento in emergenza a 400°C/2h.

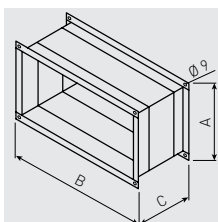

Modello	A	B	C
ACOP RECT F400-3000	150	415	140
ACOP RECT F400-4000	150	520	180
ACOP RECT F400-6000	150	670	185

ACCESSORI DI MONTAGGIO



CTI CHV
Tettuccio parapiovia
 Per installazioni esposte alle intemperie.

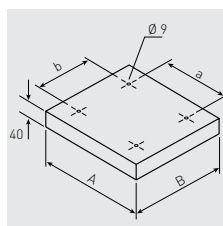

Modello	A	B	a	b
CTI CHV-3000	575	490	358	343
CTI CHV-4000	675	535	442	402
CTI CHV-6000	825	545	593	417



KSE
Supporti antivibranti
 Per evitare la trasmissione delle vibrazioni e del rumore.
 (1 KS = confezione da 4 supporti).

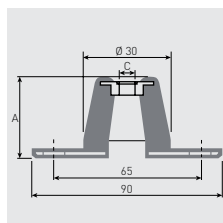

Modello	Peso ventilatore	A	C
KSE-45	40 - 180 kg	24	M8
KSE-70	80 - 280 kg	38	M8

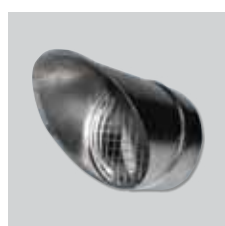

APC
Terminale di espulsione o aspirazione
 Evita l'ingresso di acqua o corpi estranei.

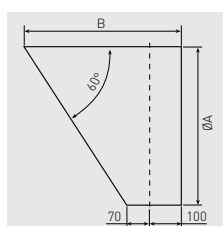

Modello	Ø A	B
APC-315	315	342
APC-355	355	365
APC-400	400	391

ACCESSORI ELETTRICI



REB
 Regolatori di velocità elettronici monofase.



RMB/RMT
 Regolatori di velocità elettromeccanici monofase e trifase.