



Classificazione: M0
 Raggio di curvatura min.: $0,6 \times \varnothing$
 Temperatura di esercizio: da -30°C a $+250^{\circ}\text{C}$

GSA-M0

Tubo flessibile in alluminio, classificazione M0, costituito da un rivestimento di alluminio e poliestere che avvolge una ossatura elicoidale in filo di acciaio.

Modello	Ø (mm)	Lunghezza (m)
GSA-M0 80 10M	80	10
GSA-M0 80 3M	80	3
GSA-M0 100 10M	100	10
GSA-M0 100 3M	100	3
GSA-M0 125 10M	125	10
GSA-M0 125 3M	125	3
GSA-M0 150 10M	150	10
GSA-M0 150 3M	150	3
GSA-M0 160 10M	160	10
GSA-M0 160 3M	160	3
GSA-M0 200 10M	200	10
GSA-M0 200 3M	200	3
GSA-M0 250 10M	250	10
GSA-M0 250 3M	250	3
GSA-M0 315 10M	315	10
GSA-M0 315 3M	315	3



Classificazione: M0/M1
 Raggio di curvatura min.: $0,7 \times \varnothing$
 Temperatura de uso: de -10°C a $+150^{\circ}\text{C}$

GSI-M0

Tubo flessibile acustico in alluminio e poliestere, classificazione M0/M1, costituito da un tubo interno perforato M0, protetto da un rivestimento di fibra di vetro sp. 25 mm e ricoperto con alluminio flessibile rinforzato con fibra di vetro M1, con un buon isolamento termico e acustico.

Modello	Ø (mm)	Lunghezza (m)
GSI-M0 125 10M	125	10
GSI-M0 125 3M	125	3
GSI-M0 160 10M	160	10
GSI-M0 160 3M	160	3
GSI-M0 200 10M	200	10
GSI-M0 200 3M	200	3
GSI-M0 250 10M	250	10
GSI-M0 250 3M	250	3
GSI-M0 315 10M	315	10
GSI-M0 315 3M	315	3



Classificazione: M1
 Raggio di curvatura min.: $0,6 \times \varnothing$
 Temperatura di esercizio: da -30°C a $+150^{\circ}\text{C}$

GAR-190/150

Tubo flessibile rettangolare in alluminio da 190 x 150 mm, lunghezza 3 metri, con una estremità circolare di diametro 200 mm.

Modello	Dimensioni (mm)	Ø equivalente (mm)	Lunghezza (m)
GAR-190/150	190 x 150	160	3



GP

Classificazione: Senza
 Raggio di curvatura min.: $0,6 \times \varnothing$
 Temperatura di esercizio: da -10°C a $+60^{\circ}\text{C}$

Tubo flessibile in PVC colore grigio con ossatura elicoidale in filo di acciaio. Normalmente impiegato in impianti individuali di VMC.

Modello	Ø (mm)	Lunghezza (m)
GP-60 6M	60	6
GP-80 6M	80	6
GP-100 6M	100	6
GP-125 6M	125	6
GP-150 6M	150	6



GPX

Classificazione: Senza
 Raggio di curvatura min.: $0,6 \times \varnothing$
 Temperatura di esercizio: da -10°C a $+80^{\circ}\text{C}$

Tubo flessibile in PVC rinforzato con poliestere, colore grigio con ossatura elicoidale in filo di acciaio.

Normalmente impiegato in impianti individuali di VMC.

Modello	Ø (mm)	Lunghezza (m)
GPX-60 6M	60	6
GPX-80 6M	80	6
GPX-100 6M	100	6
GPX-125 6M	125	6
GPX-150 6M	150	6
GPX-160 6M	160	6
GPX-200 6M	200	6



GP PRO

Classificazione: Senza
 Raggio di curvatura min.: $0,6 \times \varnothing$
 Temperatura di esercizio: da -10°C a $+60^{\circ}\text{C}$

Tubo flessibile in PVC colore grigio con ossatura elicoidale in filo di acciaio. Normalmente impiegato in impianti individuali di VMC.

Modello	Ø (mm)	Lunghezza (m)
GP-PRO 80 20M	80	20
GP-PRO 125 20M	125	20



GRX

Classificazione: Senza
 Raggio di curvatura min.: $0,6 \times \varnothing$
 Temperatura di esercizio: da -10°C a $+80^{\circ}\text{C}$

Tubo flessibile in PVC colore grigio, rinforzato (GR) o rivestito (GRX). Normalmente impiegato in impianti individuali di VMC.

Modello	Dimensioni (mm)	Ø equivalente (mm)	Lunghezza (m)
GRX 90X45 6M	90 x 45	80	6
GRX 135X70 6M	135 x 70	125	6



Classificazione: Senza
 Raggio di curvatura min.: 1 x Ø
 Temperatura di esercizio: da -10°C a +60°C

GP-ISO

Tubo flessibile isolato in PVC colore grigio, protetto da un rivestimento in fibra di vetro e da un rivestimento in polietilene.

Normalmente impiegato in impianti individuali di VMC.

Modello	Ø (mm)	Lunghezza (m)
GP-ISO 60 6M	60	6
GP-ISO 80 10M	80	10
GP-ISO 80 6M	80	6
GP-ISO 100 6M	100	6
GP-ISO 125 10M	125	10
GP-ISO 125 6M	125	6
GP-ISO 150 6M	150	6
GP-ISO 160 6M	160	6
GP-ISO 200 6M	200	6



GPR-ISO

Condotti e gomiti rigidi isolati in polietilene. Si utilizzano in installazioni di VMC unifamiliari e collettive (igroregolabili e doppio flusso).

Condotti	Ø (mm)	Lunghezza (m)
GPR-ISO 125/225	125	2,25
GPR-ISO 150/225	150	2,25
GPR-ISO 160/225	160	2,25

Gomiti 30°	Ø (mm)	Angolo
GPR-ISO 125/30 C	125	30°
GPR-ISO 150/30 C	150	30°
GPR-ISO 160/30 C	160	30°

Gomiti 345°	Ø (mm)	Angolo
GPR-ISO 125/45 C	125	45°
GPR-ISO 150/45 C	150	45°
GPR-ISO 160/45 C	160	45°

Gomiti 390°	Ø (mm)	Angolo
GPR-ISO 125/90 C	125	90°
GPR-ISO 150/90 C	150	90°

Tes	Ø (mm)	Angolo
TER-ISO 125/125	125/125	90°
TER-ISO 150/125	150/125	90°
TER-ISO 160/125	160/125	90°

Flange	Ø (mm)
CSR-ISO 125	125
CSR-ISO 150	150
CSR-ISO 160	160

Accoppiamenti	Ø (mm)
MFR-ISO 125	125
MFR-ISO 150	150
MFR-ISO 160	160

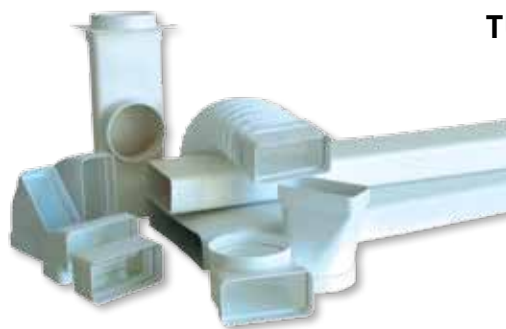

TUBPLA

Gamma di condotti ed accessori per installazioni in abitazioni unifamiliari e collettive.
Specifico per installazioni in controsoffitto con poco spazio disponibile.
Ideale per installazioni estetiche ben rifinite.
Gamma completa di accessori.
Costruiti con materiale plastico ignifugo e auto estinguibile.
Temperatura massima di esercizio +80°C.
Montaggio facile e veloce.
Versatile grazie alla sua ampia gamma di accessori.
Tenuta garantita.

Applicazioni specifiche



VMC
Abitazioni
unifamiliari



VMC
Residenza
collettiva

Tipologie di montaggio

Per installazione in controsoffitto



Con ventilatori da condotto serie TD

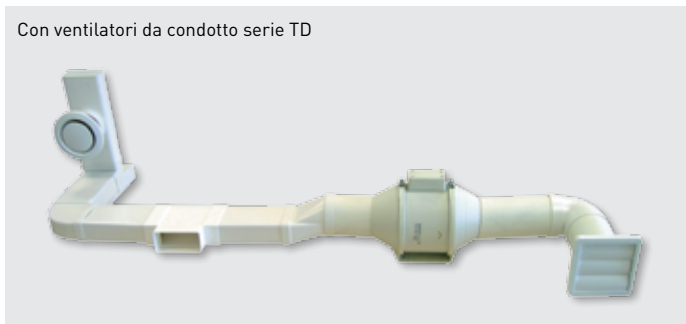

Per cappa

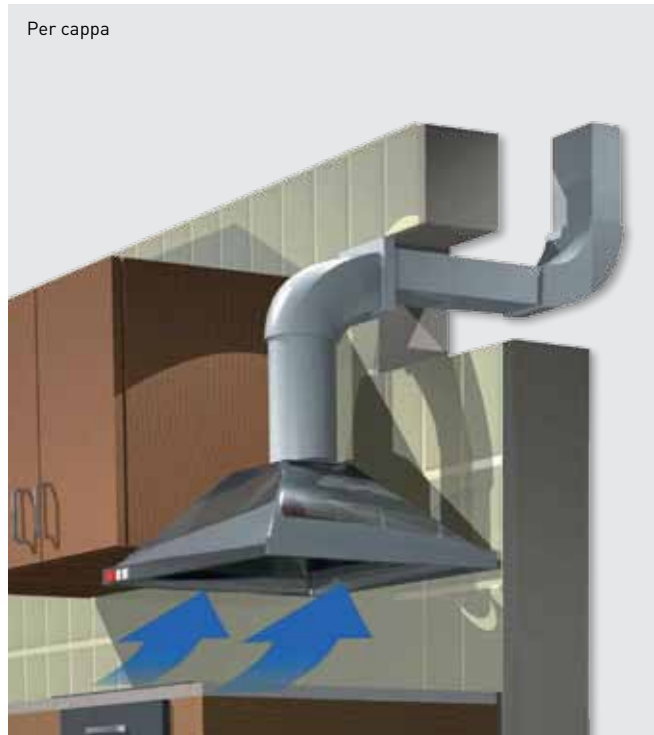

Equivalenza del diametro

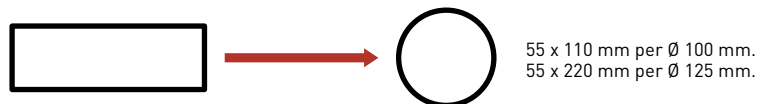

Montaggio

Montaggio con colla PVC standard.

Gamma rettangolare



Lunghezza: 1,5 m ó 3 m



Lunghezza: 50 cm



	Ø100	Ø125
	55 x 110 mm	55 x 220 mm
TPL 200		TPL 300
TFR 200		TFR 300
MCR 200		MCR 300
MCM 200		MCM 300
CHR 200		CHR 300
CHM 200		CHM 300
CVR 200		CVR 300



	Ø100	Ø125
	55 x 110 mm	55 x 220 mm
CDM 200		CDM 300
TER 200		TER 300
THR 200		THR 300
BFR 200		BFR 300
		BRM 300
		GER 300
FXR 200		FXR 300

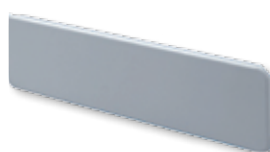

Gamma circolare



Ø100
RP 100/80



TES

Punti di registro insonorizzati.
 Permettono l'attenuazione del rumore del ventilatore, garantendo la tenuta dell'installazione.

Modello	Ø A (mm)	Ø B (mm)	H	h	R
TES 125	125	200	30	140	60
TES 160	160	250	300	140	60
TES 200	200	315	400	190	60
TES 250	250	355	400	190	60
TES 315	315	400	550	260	60
TES 355	355	450	580	280	60

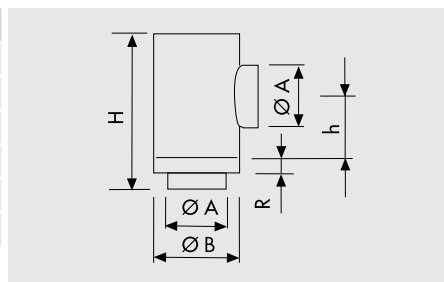

COET

Collettore pianoterra.
 Consente di collegare 1, 2 o 3 innesti di Ø 125 mm

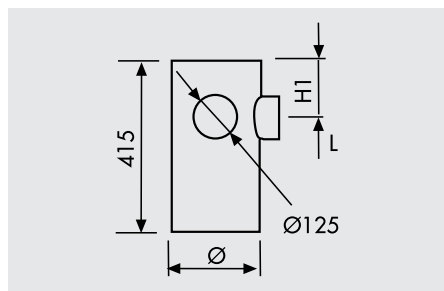

COET Ø / 1 innesto - Ø 125

Modello	H1 (mm)
COET 125/1P	130
COET 160/1P	130
COET 200/1P	130
COET 250/1P	130
COET 315/1P	130
COET 355/1P	130
COET 400/1P	170
COET 450/1P	170
COET 500/1P	170
COET 560/1P	170
COET 630/1P	170

COET Ø / 2 innesti a 90° - Ø 125

Modello	H1 (mm)
COET 125/2P/90	130
COET 160/2P/90	130
COET 200/2P/90	130
COET 250/2P/90	130
COET 315/2P/90	130
COET 355/2P/90	130
COET 400/2P/90	170
COET 450/2P/90	170
COET 500/2P/90	170
COET 560/2P/90	170
COET 630/2P/90	170

COET Ø / 2 innesti a 180° - Ø 125

Modello	H1 (mm)
COET 125/2P/180	130
COET 160/2P/180	130
COET 200/2P/180	130
COET 250/2P/180	130
COET 315/2P/180	130
COET 355/2P/180	130
COET 400/2P/180	170
COET 450/2P/180	170
COET 500/2P/180	170
COET 560/2P/180	170
COET 630/2P/180	170

COET Ø / 3 innesto - Ø 125

Modello	H1 (mm)
COET 125/3P	130
COET 160/3P	130
COET 200/3P	130
COET 250/3P	130
COET 315/3P	130
COET 355/3P	130
COET 400/3P	170
COET 450/3P	170
COET 500/3P	170
COET 560/3P	170
COET 630/3P	170

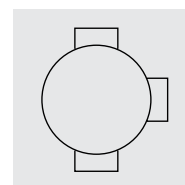
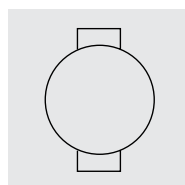
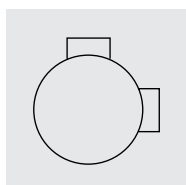
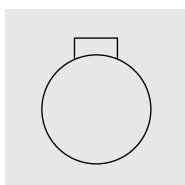



LA

Connessione acustica.
 Permette un'attenuazione di 7 dB per un accessorio RED con diametro di 80 o 125 mm.

Modello	Øa (mm)	Øb (mm)	c (mm)	d (mm)
LA 80	80	110	280	380
LA 125	125	155	260	360

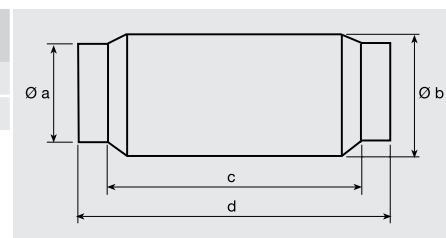

MRT

Raccordo metallico per collegare due condotti dello stesso diametro.

Modello	Ø (mm)
MRT-100	100
MRT-125	125
MRT-150	150
MRT-160	160
MRT-200	200
MRT-250	250
MRT-315	315



MRT-P

Raccordo metallico per collegare due condotti dello stesso diametro.

Modello	Ø (mm)
MRT 60 P	60
MRT 80 P	80



DERIV

Derivazioni in materiale plastico, per collegamento a condotti di differenti diametri.

Modello	Ø A (mm)	Ø B (mm)	Ø C (mm)	Ø D (mm)
DERIV 80-80 P	80	80	80	
DERIV 125-60-60-125 P	125	60	60	125
DERIV 125-60-60-60 P	125	60	60	60
DERIV 150-125-125 P	150	125	125	
DERIV 150-60-60-125 P	150	60	60	125

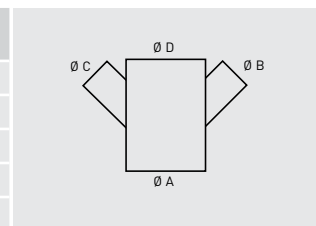



RED

Riduzioni circolari in lamiera di acciaio zincata per adattare condotti di diverso diametro.

Modello	Ø (mm)
RED-160/125	160-125
RED-200/160	200-160
RED-250/200	250-200



RED-AL

Riduzioni circolari in alluminio, per collegare due condotti di diverso diametro.

Modello	Ø (mm)
RED-160/125 AL	160-125
RED-200/125 AL	200/125
RED-200/160 AL	200/160
RED-250/160 AL	250-160
RED-250/200 AL	250-200
RED-315/200 AL	315-200
RED-315/250 AL	315-250
RED-355/250 AL	355-250
RED-355/315 AL	355-315
RED-400/315 AL	400-315
RED-400/355 AL	400-355



RED-P

Riduzioni circolari in plastica, per collegare due condotti di diverso diametro.

Modello	Ø (mm)
RED-100/80 P	100-80
RED-125/100 P	125-100
RED-150/125 P	150-125
RED-160/125 P	160-125
RED-200/160 P	200/160



CRC

Riduzioni circolari in lamiera di acciaio zincata per adattare condotti di diverso diametro.

Modello	Ø A e B (mm)	L, Lunghezza de la parte visibile (mm)
CRC-250/200	250-200	99
CRC-315/200	315-200	188
CRC-355/250	355-250	174
CRC-355/315	355-315	85
CRC-400/250	400-250	241
CRC-400/315	400-315	152
CRC-400/355	400-355	97
CRC-500/315	500-315	289
CRC-500/400	500-400	177
CRC-500/450	500-450	109

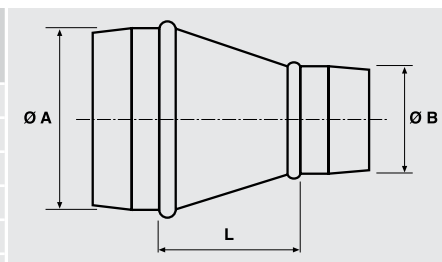

ADRF 100/80

Riduzione per il collegamento del condotto rigido Ø 100-80.

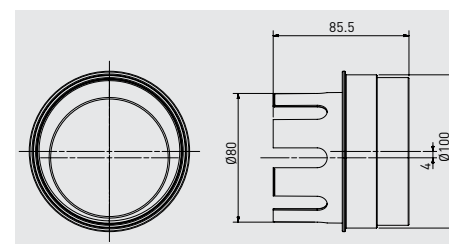

ATRF 125/100/80

Riduzione per il collegamento condotto flessibile Ø 125-100-80.

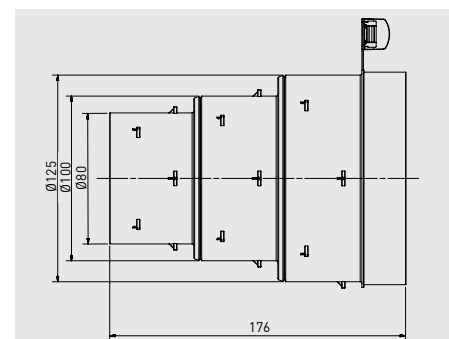

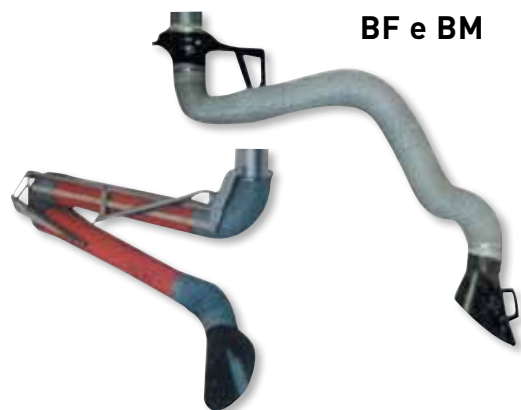

BF e BM

Bracci di aspirazione snodabili per l'estrazione di fumi di saldatura. Temperatura fino a 70°C. Facili da manovrare. Portate da 300 a 1.200 m³/h.

Installazione con connessione a condotto Ø 160: Flangia di fissaggio + Supporto a parete + Braccio di aspirazione



BF

Braccio di aspirazione flessibile. Fornito con cono di aspirazione, braccio flessibile, supporto da parete e flangia di fissaggio.

Modello	Ø Condotto (mm)	Lunghezza (m)
BF 160/3	160	3
BF 160/4	160	4



BF Configurazione-Elementi

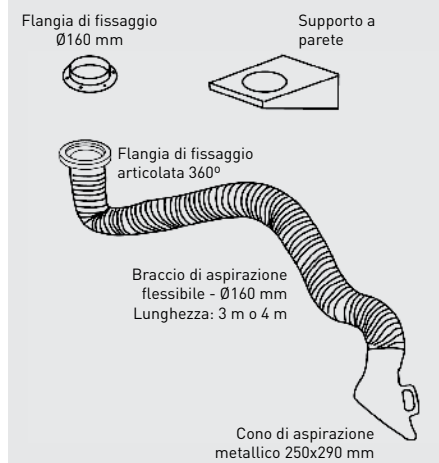

BM

Braccio di aspirazione in metallo snodabile. Fornito con cono di aspirazione, braccio di aspirazione, supporto da parete e flangia di fissaggio.

Modello	Ø Condotto (mm)	Lunghezza (m)
BM 160/3	160	3
BM 160/4	160	4



BM Configurazione-Elementi

