

ref . 29873 WHITE / BLANCO
ref . 29874 BLACK / NEGRO
1xGU10 MAX 11W

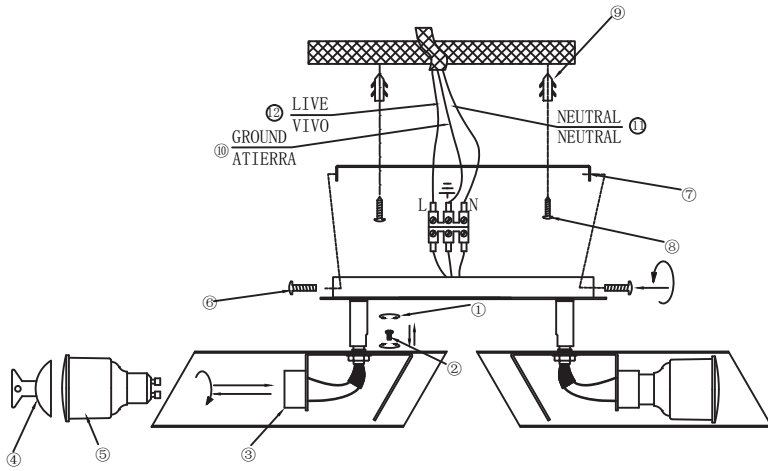

ref . 29875 WHITE / BLANCO
ref . 29876 BLACK / NEGRO
2xGU10 MAX 11W



step 3

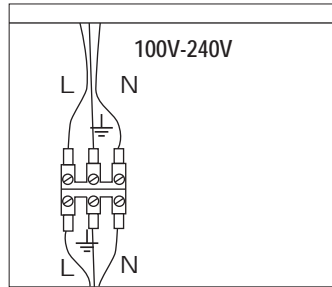

step 5

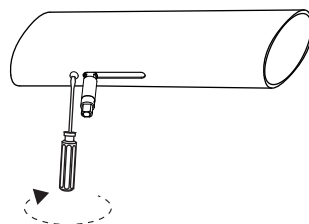
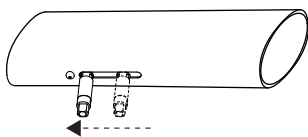
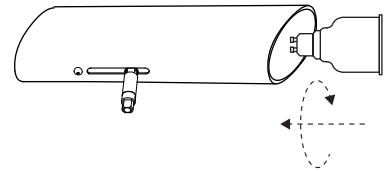
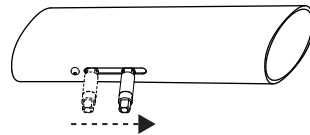
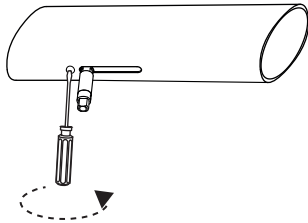

TECHNICAL FEATURES - CARACTERÍSTICAS TÉCNICAS

| | | | |
|--|------|--|---------------------|
| | 0,5m | | 100V-240V~50Hz/60Hz |
|--|------|--|---------------------|

