



Safety Instructions



0, 1, 2, 4, 6, 7, 8, 9, 11, 15, 22, 25, 27



Info Hotline +49 (0) 5041 998 389
Mon. - Do. 7⁰⁰ - 20⁰⁰
Fr. 7⁰⁰ - 17⁰⁰

Paulmann Licht GmbH
31832 Springe / Germany
www.paulmann.com

Art.-Nr.:
70.353

(+MA 173)
PJH 07/14

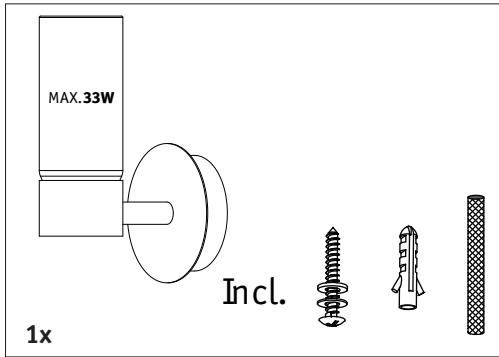

incl.
1x33W
G9

Paulmann
Art.-Nr. 800.31

