





ati

apparecchi
termo
idraulici



FLEX MINIJET UNI-1 STILO MUL-2 MUL-3 MUL-4 LAV-2

	MANUALE ISTRUZIONI	DOCCE PER ESTERNO IN ACCIAIO INOX
	INSTRUCTION MANUAL	OUTDOOR SHOWERS IN STAINLESS STEEL
	BEDIENUNGSANLEITUNG	AUßENDUSCHEN EDELSTAHL



1- INFORMAZIONI GENERALI E CARATTERISTICHE

1.1 AVVERTENZE GENERALI

Il manuale di uso e manutenzione costituisce parte integrante ed essenziale dell'apparecchio e deve essere consegnato all'utilizzatore. Va conservato con cura e consultato attentamente, in quanto contiene indicazioni importanti per la sicurezza degli operatori, per il funzionamento e per una corretta manutenzione. In caso di dubbi o incertezze sulle indicazioni fornite nel manuale, rivolgersi al costruttore.

L'apparecchio deve essere destinato solo all'uso per il quale è stato previsto. Ogni altro uso è da considerarsi improprio e quindi pericoloso.

E' esclusa qualsiasi responsabilità extracontrattuale del costruttore per i danni causati da errori nell'uso e nell'installazione dell'apparecchio, o comunque da inosservanza delle istruzioni date dal costruttore stesso.

IMPORTANTE

Il costruttore si riserva il diritto di modificare il prodotto e la relativa documentazione tecnica senza incorrere in alcun obbligo nei confronti di terzi e non assume responsabilità per eventuali errori o inesattezze nel contenuto del presente libretto. La presente stesura del manuale per l'uso e la manutenzione descrive le caratteristiche relative all'apparecchio di serie alla data in cui questa pubblicazione viene licenziata per la stampa.

1.2 COSTRUTTORE

Il costruttore è a disposizione per qualunque problema tecnico e per la richiesta di parti di ricambio.

Per qualsiasi comunicazione relativa all'apparecchio acquistato, raccomandiamo di fornire sempre i seguenti dati:

- numero di matricola (rilevabile sull'etichetta matricola)
- periodo di fabbricazione (rilevabile sull'etichetta matricola)
- data di acquisto (fotocopia scontrino fiscale o fattura)
- indicazioni dettagliate sui problemi riscontrati
- tipo di prodotto

IMPORTANTE

Per la sostituzione delle parti dell'apparecchio si raccomanda l'utilizzo di ricambi originali; il costruttore declina ogni responsabilità riguardo eventuali peggioramenti delle prestazioni dell'apparecchio per danni procurati ad esso dovuti all'uso di pezzi di ricambio non originali.

1.3 DATI PER IDENTIFICAZIONE

L'etichetta matricola per l'identificazione contiene il numero di serie dell'apparecchio ed il periodo di fabbricazione necessari per richiedere le parti di ricambio o per segnalare problemi tecnici al costruttore.

	ATI di Mariani & C. snc 47522 CESENA (FO) - ITALIA	FABBRICAZIONE - MANUFACTURED FABRICATION - FABRICACION 07/2012
COD. MINIJET-M		MADE IN ITALY
S/N T08923		

1.4 USO PREVISTO

I modelli FLEX, MINIJET, UNI-1 sono tutte dotate di un soffione doccia e di un lava piedi.

		FLEX-M	FLEX-P	FLEX-R	MINIJET-M	MINIJET-P	MINIJET-R	UNI-1M	UNI-1P	UNI-1R	STILO-M	STILO-P
SOFFIONE DOCCIA	pulsante temp.		1			1			1			1
	rubinetto manuale			1			1			1		
	miscelatore	1			1			1			1	
LAVAPIEDI	pulsante temp.		1			1			1			
	rubinetto manuale			1			1			1		

I modelli MUL-2 MUL-3 e MUL-4 sono invece studiate per avere contemporaneamente più punti di utilizzo in un unico apparecchio. A seconda del modello prevedono rispettivamente 2, 3 o 4 soffioni doccia e 1 o 2 lava piedi.

Infine il modello LAV è stato pensato soprattutto per utenze pubbliche ed è dotato di 2 punti di prelievo.

		MUL-2P	MUL-2R	MUL-3P	MUL-3R	MUL-4P	MUL-4R	LAV-2P	LAV-2R
COMANDO SOFFIONI DOCCIE	pulsante temp.	2		3		4			
	rubinetto manuale		2		3		4		
COMANDO LAVAPIEDI	pulsante temp.	1		1		2		2	
	rubinetto manuale		1		1		2		2



1- INFORMAZIONI GENERALI E CARATTERISTICHE

Tutti gli articoli della linea sono costruiti in **acciaio inox AISI 316L**, che garantisce un'ottima resistenza alla corrosione.

A seconda dei modelli, le docce sono corredate di rubinetti, di pulsanti con arresto temporizzato e di miscelatori onde evitare inutili sprechi d'acqua.

Rubinetteria e raccordi sono in ottone cromato mentre i tubi ed i raccordi interni sono in rame.

Per facilitare il collegamento dell'acqua, all'interno di tutte le versioni (ad esclusione delle versioni **xxxx-M**) è stato posto un solo tubo flessibile in acciaio inox.

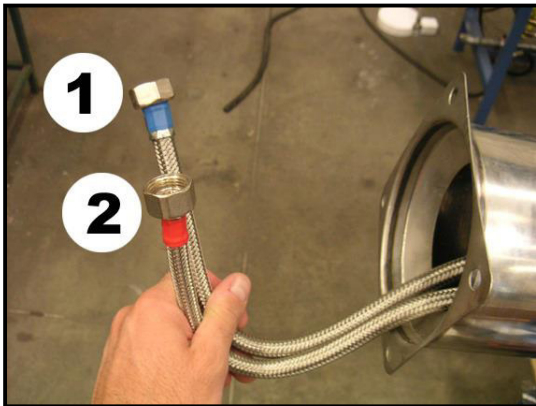

Fig_1_4_1

Le versioni **xxxx-M** prevedono invece 2 tubi flessibili in acciaio inox, uno per l'ingresso dell'acqua fredda e l'altro per l'uscita dell'acqua calda (Fig. 1.4-1):

- **nastro blu (1):** acqua fredda
- **nastro rosso (2):** acqua calda

La base può essere fissata a un basamento in legno (optional) o ad un pavimento piano semplicemente tramite viti.

IMPORTANTE

Sia le docce che il lava piedi non necessitano di pompe, centraline e apparecchiature varie. Non sono quindi necessari collegamenti elettrici.

1.5 DESCRIZIONE PARTI E DIMENSIONI

DIMENSIONE BASI DI FISSAGGIO

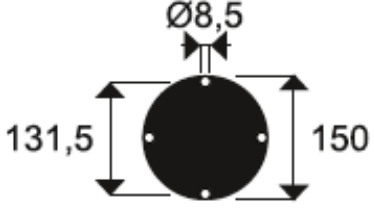
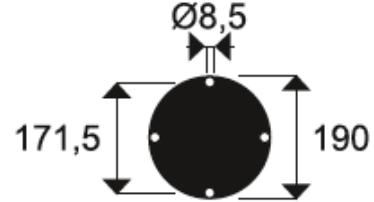
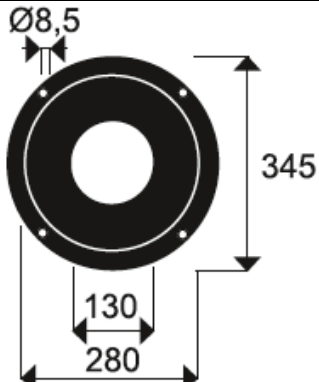
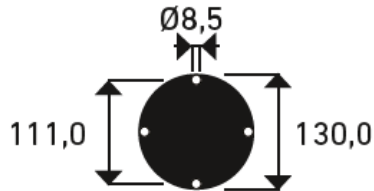
FLEX MINI UNI-1	
MUL-2 MUL-3 LAV	
MUL-4	
STILO	



1- INFORMAZIONI GENERALI E CARATTERISTICHE

MINIJET



UNI-1

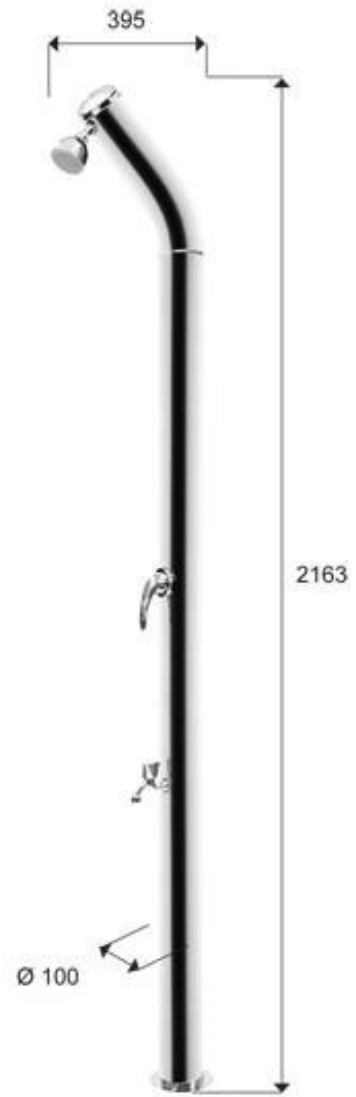

FLEX

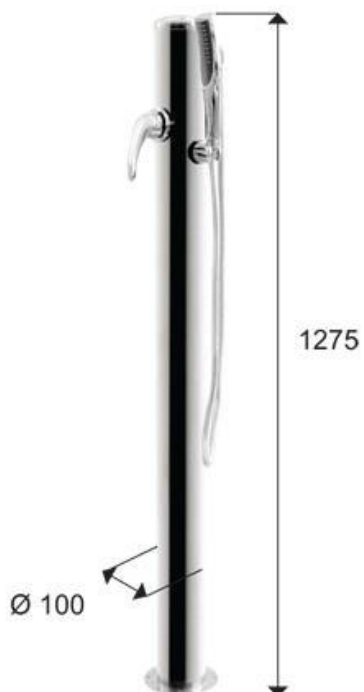

LAV-2

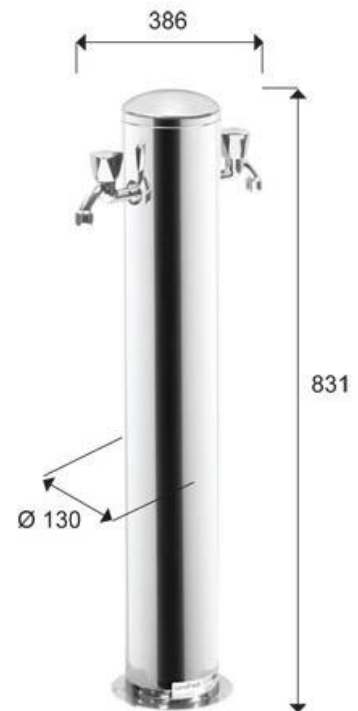



1- INFORMAZIONI GENERALI E CARATTERISTICHE

MUL-2



MUL-3

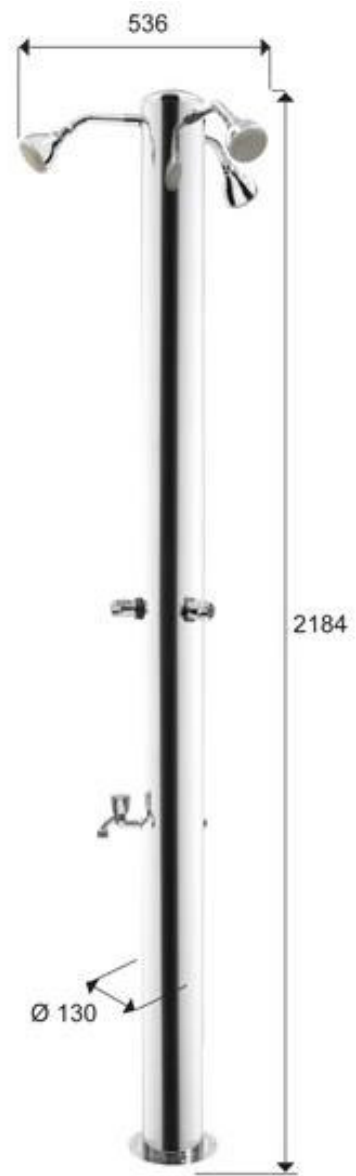



1- INFORMAZIONI GENERALI E CARATTERISTICHE

MUL-4



STILO



1.6 DATI TECNICI

Materiale ESTERNO: Acciaio inox AISI 316L
Pressione max (bar): 5

	Attacchi Acqua (tubo flessibile)
XXXX-M	2 X $\frac{3}{4}$ " F FREDDA E CALDA
XXXX-P	1 X $\frac{3}{4}$ " F
XXXX-R	1 X $\frac{3}{4}$ " F



2 - ISTRUZIONI PER L'INSTALLATORE

2.1 RACCOMANDAZIONI PER L'INSTALLAZIONE

Durante l'installazione o nel caso di interventi di manutenzione, osservare attentamente le istruzioni contenute nel presente manuale.

Le modifiche dei collegamenti di ogni genere ed il mancato rispetto delle presenti istruzioni provocano l'immediato decadimento della garanzia.

Utilizzare ricambi originali forniti dal costruttore.

2.2 IMBALLAGGIO

L'apparecchio viene consegnato imballato in una scatola di cartone con opportune protezioni. All'interno è presente una busta contenente il presente libretto ed eventuali accessori e/o componenti da montare sulla doccia.

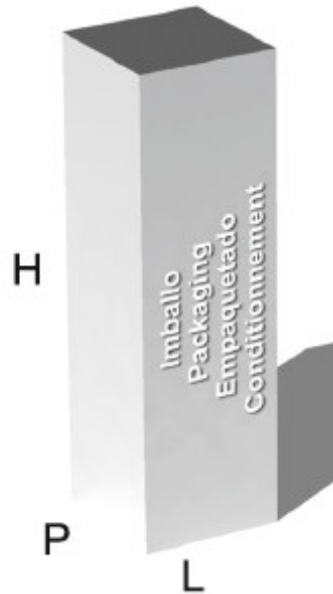

Fig. 2.2-1

imballo	Dimensioni HXLXP (cm)	Peso (Kg)
FLEX MINI	135x25x25	5,5
UNI-1 MUL-2	225x35x35	14,4
MUL-3	225x35x35	15,0
STILO	225x35x35	10,0
MUL-4	225x35x35	17,0
LAV	96X35X35	6,0
LAV	96X35X35	6,0

2.3 POSIZIONAMENTO DELLA DOCCIA

Sia le docce che il lava piedi devono essere installati solo ed esclusivamente in posizione verticale, per favorire la stabilità.

Fissare tutte le docce a pavimento o alla pedana in legno utilizzando bulloni e dadi (questi ultimi non forniti insieme alle docce), a seconda del numero di fori presenti sulla base di fissaggio della doccia.

2.4 COLLEGAMENTO IDRAULICO

Gli attacchi dell'acqua sono da $\frac{3}{4}$ ".

Il diametro dei tubi consigliato è $\frac{1}{2}$ ". Se l'installazione della doccia viene fatta molto lontana dal punto di alimentazione, è consigliato un diametro tubi di $\frac{3}{4}$ ".

IMPORTANTE

E' fondamentale prevedere l'inserimento, a monte della doccia stessa, di un filtro onde evitare che eventuali impurità vadano ad inficiare il corretto funzionamento di pulsanti, rubinetti e miscelatori.

2.5 EVENTUALI DIFETTI DI FUNZIONAMENTO

Per ottenere il getto d'acqua è necessario tenere premuto il pulsante

- soprattutto nel caso in cui non sia stato installato il filtro a monte, è possibile che qualche impurità penetrata all'interno della cartuccia abbia lacerato la piccola guarnizione che consente di realizzare quella sorta di effetto vuoto che crea il risucchio e la conseguente temporizzazione: **SOSTITUZIONE CARTUCCIA**
- molla non più in posizione corretta: **RIMETTERE LA MOLLA NELLA POSIZIONE CORRETTA**

Una volta premuto il pulsante, questo non torna più indietro o torna indietro a scatti

- impurità che va ad ostacolare il ritorno della molla, soprattutto nel caso di funzionamento con bassa pressione e mancata installazione del filtro a monte: **PULIRE LA CARTUCCIA**
- molla non più in posizione corretta: **RIMETTERE LA MOLLA NELLA POSIZIONE CORRETTA**



3 - ISTRUZIONI PER L'UTENTE

3.1 RACCOMANDAZIONI PER L'UTENTE

Leggere attentamente le istruzioni ed avvertenze contenute nel presente libretto, in quanto forniscono importanti indicazioni riguardanti la sicurezza, l'uso e la manutenzione.

Nel caso l'apparecchio dovesse essere venduto o trasferito ad altro proprietario, assicurarsi che il presente libretto accompagni lo stesso, in modo da poter essere consultato dal nuovo proprietario e/o dall'installatore.

L'apparecchio è stato costruito per l'erogazione di acqua sanitaria: qualsiasi altro tipo di utilizzo è da ritenere non idoneo e pericoloso.

Una errata installazione può provocare danni a persone, animali o cose. Il costruttore declina ogni responsabilità nel caso di inosservanza delle istruzioni da lui date.

Non appoggiare alcun tipo di oggetto sull'apparecchio.

Le parti dell'imballo (sacchetti in plastica, polistirolo, graffe, ...) non devono essere lasciate alla portata dei bambini e vanno smaltite secondo le norme vigenti nel paese d'utilizzo.

E' assolutamente vietato manomettere qualsiasi dispositivo tarato e sigillato in fabbrica dal costruttore.

IMPORTANTE

Nel caso si preveda di lasciare la doccia inutilizzata per un lungo periodo in un ambiente con possibilità di gelo, è necessario svuotarlo completamente.

Nel caso la doccia sia lasciata montata all'aperto durante il periodo invernale Si consiglia, inoltre, di proteggerla con una opportuna copertura onde preservarla dalle intemperie.

3.2 MANUTENZIONE APPARECCHIO

Pulizia doccia

Per la pulizia è sufficiente usare acqua e sapone neutro (detergenti per uso domestico) con panni non ruvidi, per evitare di opacizzare il tubo inox.

Il costruttore declina ogni responsabilità per danni dovuti all'eventuale utilizzo di solventi anticalcare, acidi o alcool.

3.3 SOSTITUZIONE CARTUCCIA PULSANTE TEMPORIZZATO

(modelli xxxx-P)

codice ricambio

vitone:

130-0120



adatto per :



3 - rimuovere il pulsante e la molla



4 - togliere il dado anello interno



5 - svitare la cartuccia



6 - rimuovere e sostituire la cartuccia

IMPORTANTE

Il tempo di erogazione è all'incirca di 15'' ma può risultare superiore se vi è una pressione inferiore a 2 atm e inferiore se vi è una pressione superiore a 4 atm.

La ghiera interna può essere montata sia in posizione standard sia in posizione rovesciata: in questo secondo caso si ha una riduzione di circa 5'' del tempo di erogazione:



7 - ghiera in posizione standard



8 - ghiera in posizione rovesciata

IMPORTANTE

- Se l'acqua di alimentazione contiene impurità, è indispensabile installare un filtro adeguato
- Per un corretto funzionamento la pressione consigliata è da 2 a 4 bar



3 - ISTRUZIONI PER L'UTENTE

3.4 SOSTITUZIONE CARTUCCIA MISCELATORE

(modelli xxxx-M)

codice ricambio
cartuccia: 130-0191

adatto per:



11 - miscelatore montato



12 - allentare la vite della maniglia



13 - togliere la maniglia



14 - svitare la ghiera cromata copri-dado



15 - svitare il dado in ottone



16 - estrarre la cartuccia

3.5 GARANZIA CONVENZIONALE

Le docce sono garantite dal costruttore contro vizi o difetti di fabbricazione, secondo le direttive vigenti in materia, ad esclusione di naturali alterazioni dei materiali per la costante esposizione al sole.

L'acquirente può esercitare nei confronti del venditore il diritto alla riparazione o sostituzione in garanzia per la durata di:

- 24 mesi dalla data di consegna e/o acquisto, nel caso l'acquirente sia persona fisica che agisce per fini che non rientrano nell'ambito della sua attività commerciale e professionale (Direttiva 99/44/CEE e relativo decreto di recepimento DL 2 Febbraio 2002, n. 24)
- 12 mesi dalla data di consegna e/o acquisto, in tutti gli altri casi non contemplati al punto 1 (art. 1591 c.c.)

La data d'acquisto dovrà essere obbligatoriamente comprovata da un documento fiscale (scontrino fiscale o fattura).

La presente garanzia convenzionale lascia impregiudicati i diritti derivanti dalla sopracitata Direttiva 99/44/CEE e non esclude né limita diritti che derivano da altre Norme dell'ordinamento giuridico del Paese d'utilizzo.

Sono altresì esclusi dalla garanzia deterioramenti ed alterazioni del prodotto o dei suoi elementi determinati da altre cause, quali:

- a) errata installazione (utilizzo a pressione superiore alla pressione massima consentita) errata manutenzione o mancanza della stessa
- b) manomissione da parte di persone non autorizzate e/o qualificate
- c) utilizzo del prodotto con scopi diversi da quelli per cui è stato concepito (utilizzo di sostanze diverse dall'acqua)
- d) causa di forza maggiore o eventi catastrofici (gelo, incendio, inondazioni, fulmini, atti vandalici, ecc...)
- e) trasporto e/o cattiva conservazione
- f) qualsiasi fattore o fenomeno estraneo alle normali condizioni d'uso e di funzionamento dell'apparecchio (formazione di calcare o fanghi, corrosioni anomale, aggressività o acidità dell'acqua anche se derivanti da trattamenti della stessa, trattamenti disincrostanti o di pulizia effettuati impropriamente)
- g) utilizzo di parti di ricambio, componenti ed accessori non originali

Ad ogni modo la **GARANZIA** è valida solo per il primo acquirente e non contempla la sostituzione dell'apparecchio.

Qualora il costruttore provi e riconosca che il prodotto o uno dei suoi componenti presenta un vizio di materiale, a proprio insindacabile giudizio, potrà ripararlo o sostituirlo gratuitamente. In entrambe i casi sarà data continuità alla garanzia originale.



1- GENERAL INFORMATION AND FEATURES

1.1 GENERAL WARNINGS

The operating and maintenance is an integral and essential equipment and should be delivered to the user. It should be stored carefully and consulted carefully, as it contains important information on the safety of operators, for the operation and for proper maintenance. In case of doubt or for more information in the manual, contact the manufacturer. The appliance must only be used for which it was intended. Any other use is considered improper and therefore dangerous.

And 'it is excluding any non-contractual liability of the manufacturer for damages caused by errors in the use and installation of the appliance, or failure to comply with the instructions provided by the manufacturer.

IMPORTANT

The manufacturer reserves the right to modify the product and its technical documentation without incurring any liability to third parties and assumes no responsibility for any errors or imprecision in the content of this booklet. The present drafting of the manual for the use and maintenance describes the characteristics about the appliance of the series the date on which this publication is fired for printing.

1.2 MANUFACTURER

The manufacturer is available to technical problems or for ordering spare parts.

For any communication device purchased, we recommend to always provide the following information:

- serial number (serial detectable label)
- period of manufacture (detectable label serial)
- date of purchase (receipt or invoice copy)
- Detailed information about problems found
- product type

IMPORTANT

To replace some components we recommend the use of original spare parts; the manufacturer declines all responsibility for any deterioration of the device performance for damages caused to it due to the use of spare parts not original.

1.3 FOR IDENTIFICATION DATA

The label contains the serial number for identifying the device serial number and the manufacturing time needed to apply for spare parts or to report technical problems to the manufacturer.



1.4 INTENDED USE

The FLEX models, MINIJET, UNI-1 are all equipped with a shower head and a foot lava.

		FLEX-M	FLEX-P	FLEX-R	MINIJET-M	MINIJET-P	MINIJET-R	UNI-1M	UNI-1P	UNI-1R	STILO-M	STILO-P
SHOWER	temp button.		1			1			1			1
	tap manual			1		1				1		
	mixer	1			1			1			1	
FOOTWASH	temp button.		1			1			1			
	tap manual			1		1				1		

The MUL-2 MUL-3 models and MUL-4 are designed to simultaneously have more points of use in a single device. Depending on the model provide respectively 2, 3 or 4 shower heads and 1 or 2 washes feet.

Finally, the LAV model has been especially designed for public utilities and is equipped with 2 sampling points.

		MUL-2P	MUL-2R	MUL-3P	MUL-3R	MUL-4P	MUL-4R	LAV-2P	LAV-2R
CONTROL SHOWER HEADS	temp button.	2		3		4			
	tap manual		2		3		4		
COMMAND FOOTWASH	temp button.	1		1		2		2	
	tap manual		1		1		2		2

All items in the line are built in AISI 316L stainless steel, which provides excellent corrosion resistance.



1- GENERAL INFORMATION AND FEATURES

Depending on the model, the showers are equipped with valves, pressure buttons with timed stop and wave mixers avoid unnecessary waste of water. Taps and fittings are chrome-plated brass, while the tubes and the internal fittings are made of copper. To facilitate the water connection, within all versions (with the exception of xxxx-M versions) it was placed only a flexible tube made of stainless steel.

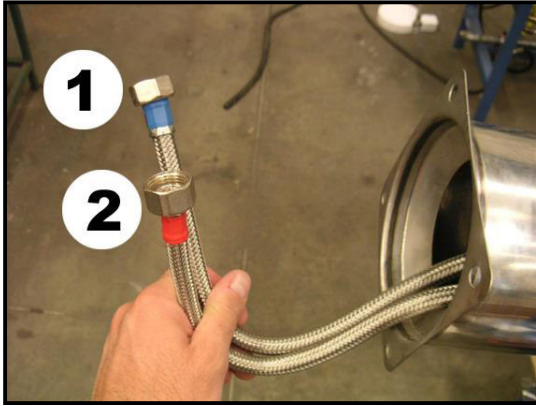

Fig_1_4_1

The versions xxxx-M provide instead 2 hoses in stainless steel, one for cold water inlet and the other to the hot water outlet (Fig. 1.4-1):

- **blue ribbon (1):** cold water
- **red ribbon (2):** hot water

The base can be fixed to a wooden base (optional) or to a flat floor simply by means of screws.

IMPORTANT

Both the showers that washes the feet do not require pumps, control and equipment. There are therefore required electrical connections.

1.5 DESCRIPTION OF PARTS AND DIMENSIONS

SIZE FIXING BASES

<p>FLEX MINI UNI-1</p>	
<p>MUL-2 MUL-3 LAV</p>	
<p>MUL-4</p>	
<p>STILO</p>	



1- GENERAL INFORMATION AND FEATURES

MINIJET



FLEX

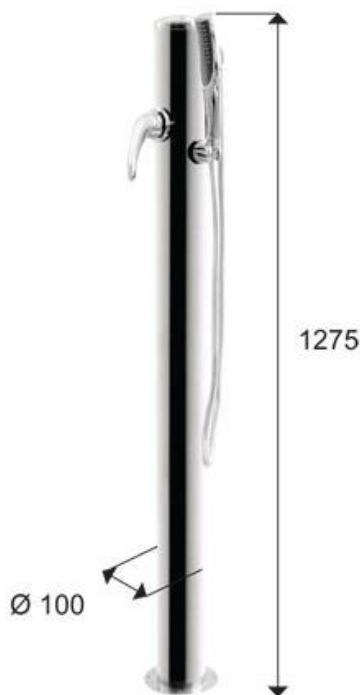

UNI-1

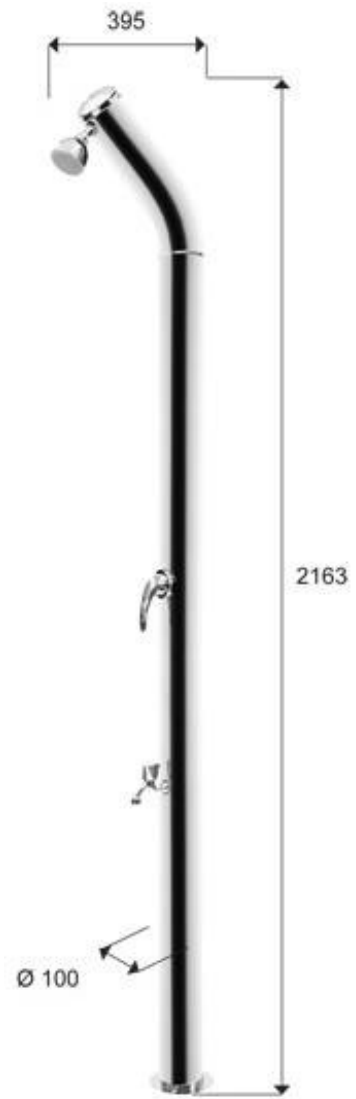

LAV-2

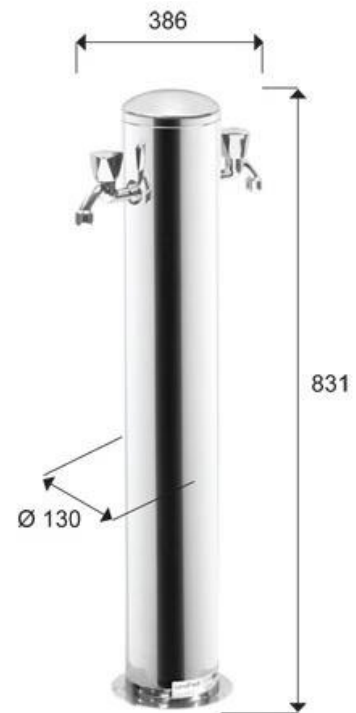



1- GENERAL INFORMATION AND FEATURES

MUL-2

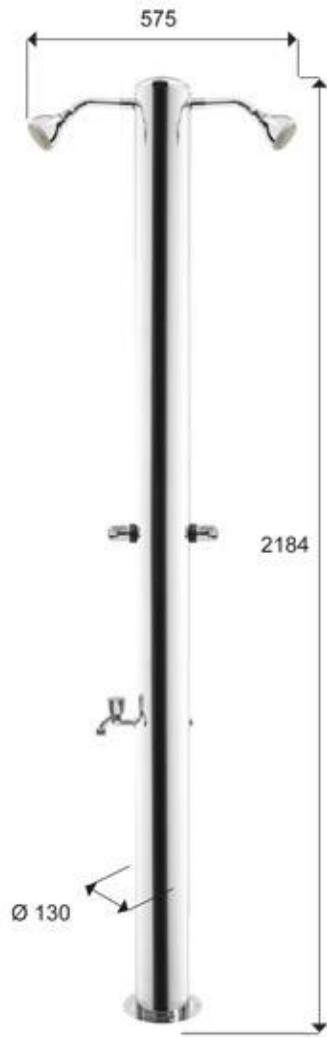

MUL-3

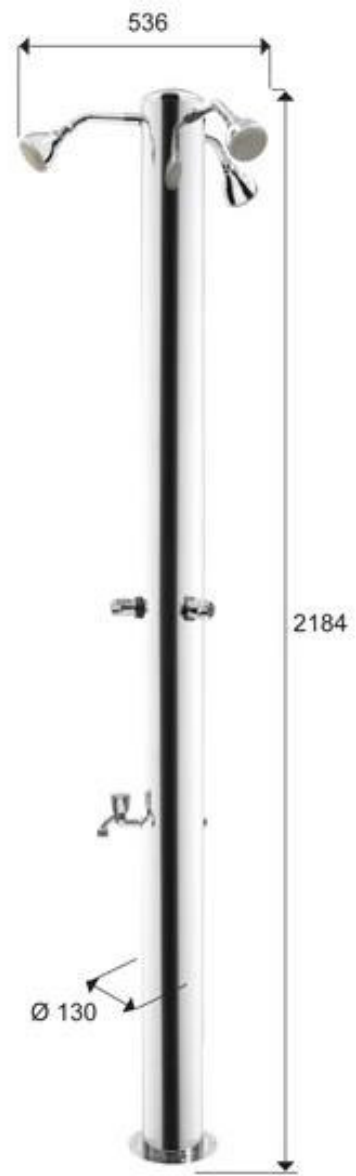



1- GENERAL INFORMATION AND FEATURES

MUL-4



STILO



1.6 TECHNICAL DATA

OUTSIDE Material: Stainless steel AISI 316L
Maximum pressure (bar): 5

	Water Attacks (hose)
XXXX-M	2 X $\frac{3}{4}$ " HOT AND COLD
XXXX-P	1 X $\frac{3}{4}$ "
XXXX-R	1 X $\frac{3}{4}$ "



2 - INSTALLATION INSTRUCTIONS

2.1 INSTALLATION RECOMMENDATIONS

During installation, or in the case of maintenance, carefully follow the instructions outlined in this manual.

Changes of any connections or the non-compliance with these instructions will immediately invalidate the warranty.

Use original spare parts supplied by the manufacturer.

2.2 PACKAGING

The device is delivered packed in a cardboard box with appropriate protection.

Inside there is an envelope containing this booklet and any accessories and / or components to be mounted on the shower.

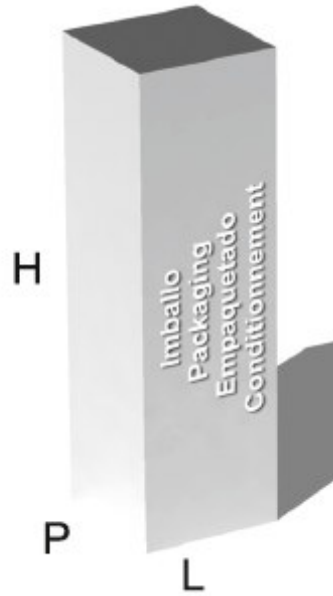

Fig. 2.2-1

packaging	dimensions WXHxD (cm)	Weight (Kg)
FLEX MINI	135x25x25	5.5
UNI-1 MUL-2	225x35x35	14.4
MUL-3	225x35x35	15.0
STILO	225x35x35	10.0
MUL-4	225x35x35	17.0
LAV	96X35X35	6.0
LAV	96X35X35	6.0

2.3 POSITIONING THE SHOWER

Both the showers that washes the feet must be installed only and exclusively in a vertical position, in order to promote stability.

Secure all floor-level showers or wooden platform using bolts and nuts (the latter not supplied together with the showers), depending on the number of holes in the base of the shower attachment.

2.4 WATER CONNECTION

The water connections are $\frac{3}{4}$ ".

The diameter of the tubes is recommended $\frac{1}{2}$ ". If the shower installation is made very distant from the feeding point, a diameter of pipes $\frac{3}{4}$ " it is recommended.

IMPORTANT

It's essential to provide the insertion, upstream of the shower itself, of a filter in order to avoid any impurities that go to affect the proper operation of buttons, taps and mixers.

2.5 POSSIBLE OPERATING FAULTS

To get the water jet is necessary to hold the button

- especially in the case where the upstream filter, it has not been installed it is possible that some impurities penetrated inside the cartridge has torn the small gasket that allows to implement this kind of vacuum effect that creates the suction and the consequent timing: **REPLACEMENT CARTRIDGE**
- spring no longer in the correct position: **REPLACE SPRING IN POSITION PROPER**

After pressing the button, this does not come back or back to back shots

- impurities that goes to obstruct the return of the spring, especially in the case of operation with low pressure and failure to install the upstream filter: **CLEAN THE CARTRIDGE**
- spring no longer in the correct position: **REPLACE SPRING IN POSITION PROPER**



3 - INSTRUCTIONS FOR THE USER

3.1 RECOMMENDATIONS FOR YOU

Carefully read the instructions and warnings contained in this booklet, as they provide important information about safety, use and maintenance.

In case the appliance is sold or transferred to another owner, ensure that this booklet accompanies the same, so that they can be consulted by the new owner and / or installer.

The device has been constructed for the delivery of sanitary water: any other type of use is to be considered as dangerous and unsuitable.

Incorrect installation can cause damage to people, animals or property. The manufacturer declines all responsibility in case of failure to follow instructions given by him.

Do not place any kind on the subject.

The packaging components (plastic bags, polystyrene, staples, ...) must not be left within reach of children and must be disposed of according to current regulations in the country of use.

It 'not tamper with any device calibrated and sealed at the factory by the manufacturer.

IMPORTANT

If you plan to leave the shower for an extended period in an environment with the possibility of frost, it must be emptied completely.

If the shower is left mounted outdoors during the winter period it is also recommended to protect it with a suitable cover in order to preserve it from the weather.

3.2 MAINTENANCE EQUIPMENT

Clean shower

For cleaning, it is sufficient to use water and neutral soap (detergents for domestic use) with cloths not rough, to avoid dulling the steel tube.

The manufacturer accepts no responsibility for damage due to the possible use of anti-solvents, acids or alcohol.

3.3 CARTRIDGE BUTTON TIMED

(Xxxx-P models)

Cartridge button
spare parts:
130-0120



suitable for:



3 - remove the button and the spring



4 - remove the inner ring nut



5 - Remove the cartridge



6 - remove and replace the cartridge

IMPORTANT

The delivery time is approximately 15 " but may be higher if there is a pressure lower than 2 atm and lower if there is a pressure higher than 4 atm.

The inner ring may be mounted either in the standard position is in the inverted position: in this second case there is a reduction of about 5 " of the dispensing time:



7 - ring in the standard position



8 - ring in the inverted position

IMPORTANT

- If the feed water contains impurities, it is essential to install a suitable filter
- For proper operation, the recommended pressure is from 2 4 bar



3 - INSTRUCTIONS FOR THE USER

3.4 CARTRIDGE MIXER

(Xxxx-M models)

Replacement cartridge
code: 130-0191

suitable for:



11 - mixer mounted



12 - loosen the screw
of the handle



13 - remove the handle



14 - unscrew the ring
chromed cover-nut



15 - unscrew the brass
nut



16 - remove the
cartridge

3.5 CONVENTIONAL WARRANTY

The showers are guaranteed by the manufacturer against defects or manufacturing defects, according to the directives in force, to the exclusion of natural changes in the material for the constant exposure to the sun.

The buyer may assert against the seller the right to repair or replacement under warranty for a period of:

- 24 months from the date of delivery and / or purchase, if the purchaser is a natural person acting for purposes which are outside the scope of its commercial and professional activities (Directive 99/44 / EEC and its implementing decree DL February 2 2002, n. 24)
- 12 months from the date of delivery and / or purchase, in all other cases not referred to in paragraph 1 (art. 1591 cc)

The date of purchase must be mandatorily certified by a tax document (receipt or invoice).

This standard warranty does not affect any rights under the aforementioned Directive 99 / 44CEE and does not exclude or limit the rights deriving from other legal system standards of the country of use.

Also they excluded from the warranty deterioration or alteration of the product or its certain elements from other causes, such as:

- a) incorrect installation (use a pressure higher than the maximum allowable pressure) improper maintenance or lack thereof
- b) tampering by unauthorized persons and / or qualified
- c) use of the product with different purposes other than those for which it was designed (use of substance other than water)
- d) due to major or catastrophic events (frost strength, fire, floods, lightning, vandalism, etc ...)
- e) transport and / or improper storage
- f) any factor or alien phenomenon to the normal conditions of use and operation of the appliance (formation of scale or sludge, abnormal corrosion, aggression or acidity of the water even if originating from the same treatments, descaling or cleaning treatments carried out improperly)
- g) Use of replacement parts, components and accessories that are not original

Anyway guarantee It applies only to the original purchaser and does not include fixture replacement.

Where the manufacturer try and recognize that the product or one of its components has a defective materials, in its sole discretion, will repair or replace it for free. In both cases it will be given continuity to the original warranty.



1- ALLGEMEINE INFORMATIONEN UND FUNKTIONEN

1.1 ALLGEMEINE HINWEISE

Der Betrieb und Wartung ist eine integrale und wichtige Ausrüstung und soll an den Benutzer geliefert werden. Es sollte sorgfältig und konsultiert sorgfältig aufbewahrt werden, da sie wichtige Informationen über die Sicherheit von Menschen, die für den Betrieb und für die ordnungsgemäße Wartung enthält. Im Zweifelsfall oder für weitere Informationen im Handbuch, an den Hersteller.

Das Gerät darf nur verwendet, für die es bestimmt war. Jede andere Verwendung ist unsachgemäß und daher gefährlich.

Und es wird unter Ausschluss jeglicher außervertragliche Haftung des Herstellers für Schäden, die durch Fehler in der Anwendung und Installation des Gerätes verursacht werden, oder Nichtbeachtung der Anweisungen des Herstellers zu beachten.

WICHTIG

Der Hersteller behält sich das Recht vor, das Produkt und seine technische Dokumentation zu ändern, ohne jegliche Haftung gegenüber Dritten entstehen und übernimmt keine Verantwortung für Fehler oder Ungenauigkeiten in den Inhalt dieser Broschüre. Die vorliegende Entwurf des Handbuchs für die Nutzung und Wartung beschreibt die Eigenschaften über das Gerät der Serie, auf dem das Datum dieser Veröffentlichung für den Druck gebrannt wird.

1.2 HERSTELLER

Der Hersteller zur Verfügung zu technischen Problemen oder für Ersatzteilbestellungen. Für jedes Kommunikationsgerät erworben hat, empfehlen wir immer die folgenden Informationen zur Verfügung zu stellen:

- Seriennummer (serial detektierbare Markierung)
- Zeitraum der Herstellung (nachweisbare Markierung seriell)
- Kaufdatum (Quittung oder Rechnung Kopie)
- Detaillierte Informationen über Probleme gefunden
- Produktart

WICHTIG

So ersetzen Sie einige Komponenten wir die Verwendung von Original-Ersatzteile zu empfehlen; Der Hersteller lehnt jede Verantwortung für eine Verschlechterung der Leistung der Vorrichtung für Schäden, es verursacht durch die Verwendung von Ersatzteilen nicht original.

1.3 FÜR IDENTIFIKATIONS DATEN

Das Etikett enthält die Seriennummer für die Geräte-Seriennummer zu identifizieren und die Herstellungszeit für Ersatzteile, die erforderlich sind oder technische Probleme an den Hersteller zu melden.

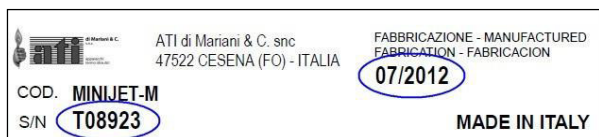

1.4 VERWENDUNGSZWECK

Die FLEX-Modelle, MINIJET, UNI-1 sind alle mit einem Duschkopf und einen Fuß Lava ausgestattet.

		FLEX-M	FLEX-P	FLEX-R	MINIJET-M	MINIJET-P	MINIJET-R	UNI-1M	UNI-1P	UNI-1R	STILO-M	STILO-P
DUSCHE	Temp-Taste.		1			1			1			1
	Zapfhahn Handbuch			1			1			1		
	Rührgerät	1			1			1			1	
FOOTWASH	Temp-Taste.		1			1			1			
	Zapfhahn Handbuch			1			1			1		

Die MUL-2 MUL-3-Modelle und MUL-4 sind so ausgelegt, um gleichzeitig mehr Verwendungspunkt in einem einzigen Gerät. Je nach Modell liefert jeweils 2, 3 oder 4 Brausen und 1 oder 2 Wäschen Füße.

Schließlich wurde das LAV-Modell speziell für öffentliche Versorgungs ausgebildet und mit 2 Abtastpunkten ausgestattet.

		MUL-2P	MUL-2R	MUL-3P	MUL-3R	MUL-4P	MUL-4R	LAV-2P	LAV-2R
CONTROL- Duschköpfe	Temp-Taste.	2		3		4			
	Zapfhahn Handbuch		2		3		4		
BEFEHL FOOTWASH	Temp-Taste.	1		1		2		2	
	Zapfhahn Handbuch		1		1		2		2



1- ALLGEMEINE INFORMATIONEN UND FUNKTIONEN

Alle Artikel in der Linie sind in AISI 316L Edelstahl gebaut, die eine ausgezeichnete Korrosionsbeständigkeit bietet.

Je nach Modell sind die Duschen mit Ventilen, Drucktasten mit zeitlich abgestimmten Abstellung und Wellenmischer unnötige Verschwendung von Wasser zu vermeiden.

Armaturen sind verchromtem Messing, während die Rohre und die Einbauten aus Kupfer sind.

Um den Wasseranschluss zu erleichtern, in allen Versionen (mit Ausnahme von xxxx-M-Versionen) nur ein flexibles Rohr aus rostfreiem Stahl gelegt.

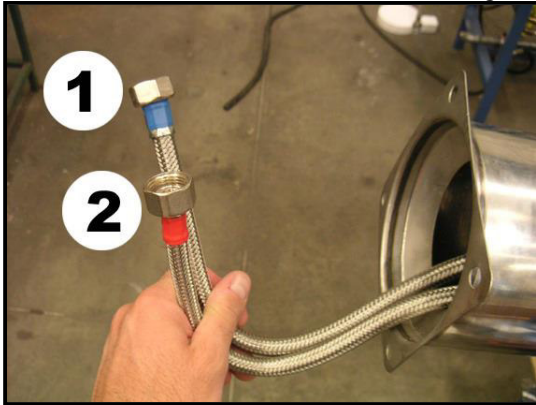

Fig_1_4_1

Die Versionen XXXX-M liefern, anstatt 2 Schläuche aus Edelstahl, einem für das Kaltwassereinlass und der andere mit dem Heisswasserauslass (Abb 1.4-1.):

- **blaue Band (1):** kaltes Wasser
- **rotes Band (2):** heißes Wasser

Die Basis kann auf eine Holzunterlage befestigt werden (optional) oder auf einen flachen Boden einfach mit Hilfe von Schrauben.

WICHTIG

Sowohl die Duschen, die die Füße wäscht benötigen keine Pumpen, Steuerung und Ausrüstung.

Es gibt deshalb erforderliche elektrische Verbindungen.

1.5 BESCHREIBUNG DER TEILE UND ABMESSUNGEN

SIZE FIXING GRUNDLAGEN

<p>BIEGEN MINI UNI-1</p>	
<p>MUL-2 MUL-3 LAV</p>	
<p>MUL-4</p>	
<p>STILO</p>	



1- ALLGEMEINE INFORMATIONEN UND FUNKTIONEN

MINIJET



BIEGEN

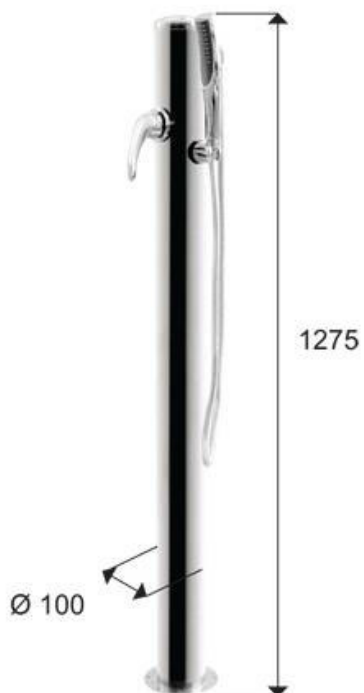

UNI-1

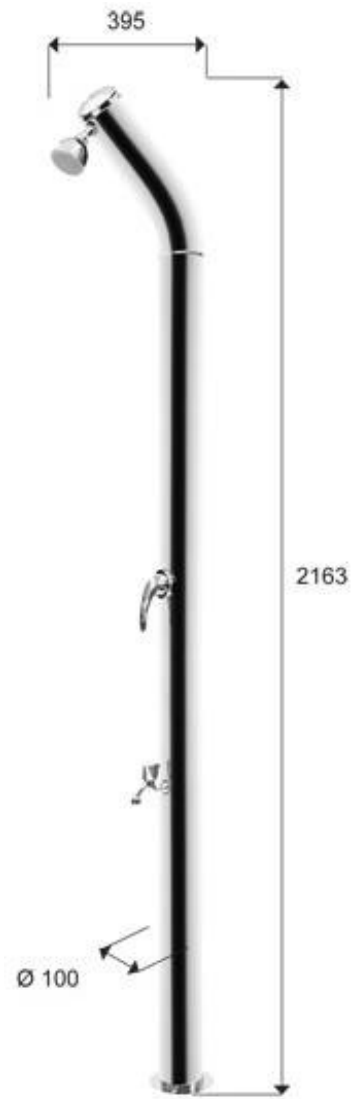

LAV-2

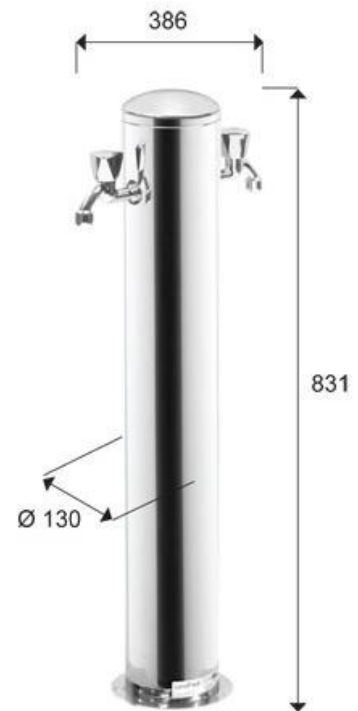



1- ALLGEMEINE INFORMATIONEN UND FUNKTIONEN

MUL-2



MUL-3

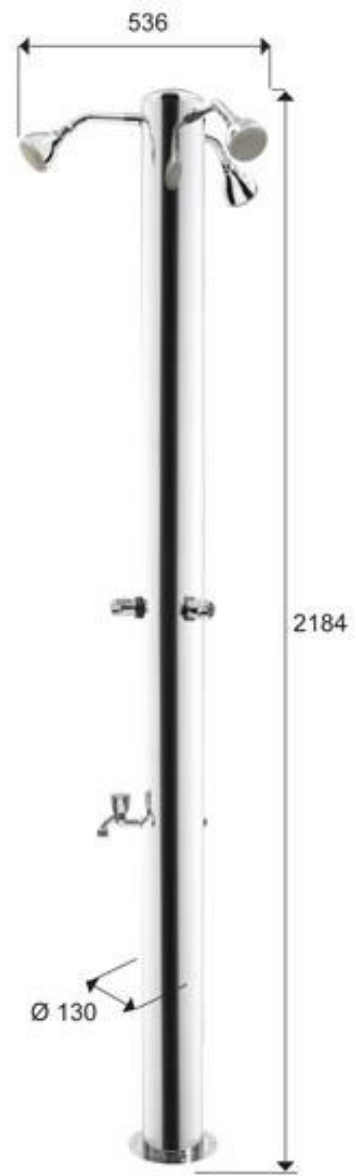



1- ALLGEMEINE INFORMATIONEN UND FUNKTIONEN

MUL-4



STILO



1.6 TECHNISCHE DATEN

Außenmaterial: Edelstahl AISI 316L

Maximaler Druck (bar): 5

	Wasser Attacks (Schlauch)
XXXX-M	2 X 3/4 " HEISS UND KALT
XXXX-P	X 1 3/4 "
XXXX-R	X 1 3/4 "



2 - INSTALLATIONSANLEITUNG

2.1 EMPFEHLUNGEN FÜR DIE INSTALLATION

Während der Installation oder im Fall von Wartung, befolgen Sie die in diesem Handbuch beschriebenen Anweisungen.

Änderungen von irgendwelchen Verbindungen oder der Nichteinhaltung dieser Vorschriften werden sofort die Garantie erlischt.

Verwenden Sie nur Original-Ersatzteile vom Hersteller geliefert.

2.2 VERPACKUNG

Das Gerät ist in einem Karton mit entsprechendem Schutz verpackt geliefert.

Im Innern befindet sich ein Umschlag Diese Broschüre und alle Zubehörteile und / oder Komponenten enthält, auf der Dusche montiert werden.

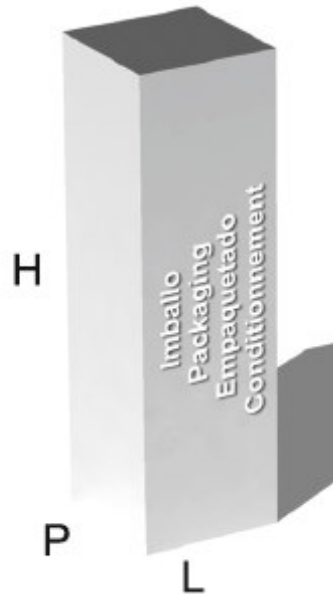

Fig. 2.2-1

Verpackung	Maße BXHXT (cm)	Gewicht (Kg)
BIEGEN MINI	135x25x25	5.5
UNI-1 MUL-2	225x35x35	14.4
MUL-3	225x35x35	15,0
STILO	225x35x35	10.0
MUL-4	225x35x35	17.0
LAV	96X35X35	6.0
LAV	96X35X35	6.0

2.3 PLATZIERUNG der Dusche

Sowohl die Duschen, die die Füße waschen dürfen nur und ausschließlich in vertikaler Lage eingebaut werden, um die Stabilität zu fördern.

Sichern aller bodengleiche Dusche oder Holzplattform unter Verwendung von Bolzen und Muttern (letztere nicht mit den Duschen zusammen mitgeliefert), abhängig von der Anzahl der Löcher in der Basis der Duschorruchtung.

2.4 WASSERVERBINDUNG

Die Wasseranschlüsse sind 3/4".

Der Durchmesser der Rohre wird empfohlen 1/2. „Wenn die Duscheinrichtung vom Einspeisepunkt sehr weit entfernte hergestellt ist, ein Durchmesser von Rohren 3/4“ Es wird empfohlen.

WICHTIG

Es ist wichtig, die Einführung, vor der Dusche selbst bereitzustellen, einen Filters, um eventuelle Verunreinigungen zu vermeiden, die den ordnungsgemäßen Betrieb von Tasten, Armaturen beeinflussen gehen.

2.5 Mögliche Fehlerzustände

Um den Wasserstrahl zu erhalten, ist notwendig, um die Taste zu halten

- insbesondere in dem Fall, wo die vorgeschalteten Filter, ist es nicht installiert worden ist, ist es möglich, dass einige in der Kartusche penetriert Verunreinigungen hat die kleine Dichtung zerrissen, die diese Art von Vakuumeffekt implementieren können, die das Ansaugen und die daraus folgende Timing erzeugt: **REPLACEMENT CARTRIDGE**
- Frühling nicht mehr in der richtigen Position: **REPLACE SPRING** in der richtigen Position

Nach dem Drücken der Taste kommt nicht zurück oder wieder Schüsse zu unterstützen

- Verunreinigungen, die die Rückkehr der Feder, insbesondere bei Betrieb mit niedrigem Druck und Versagen installieren den vorgeschalteten Filter zu versperren geht: Reinigen der Patrone
- Frühling nicht mehr in der richtigen Position: **REPLACE SPRING** in der richtigen Position



3 - FÜR DEN USER

3.1 EMPFEHLUNGEN FÜR SIE

Lesen Sie sorgfältig die Anweisungen und Warnungen in dieser Broschüre enthalten sind, da sie wichtige Hinweise zur Sicherheit, Verwendung und Wartung.

Falls das Gerät an einem anderen Eigentümer verkauft oder übertragen, stellen Sie sicher, dass diese Broschüre die gleiche begleitet, so dass sie durch den neuen Eigentümer zu Rate gezogen werden können und / oder Installateur.

Das Gerät wurde für die Lieferung von Sanitärwasser konstruiert: jede andere Art von Anwendung ist als gefährlich und ungeeignet angesehen werden.

Eine falsche Installation kann Schäden an Personen, Tieren oder Gegenständen verursachen. Der Hersteller lehnt jede Verantwortung im Fall des Scheiterns Anweisungen von ihm zu befolgen.

Stellen Sie keine Art zu diesem Thema.

Die Verpackungsteile (Plastiktüten, Polystyrol, Heftklammern, ...) dürfen nicht in Reichweite von Kindern gelassen werden und müssen gemäß den geltenden Vorschriften im Einsatzland entsorgt werden.

Es nicht mit jedem Gerät manipulieren kalibriert und in der Fabrik durch den Hersteller versiegelt.

WICHTIG

Wenn Sie die Dusche verlassen für einen längeren Zeitraum in einer Umgebung mit der Möglichkeit des Frostes planen, müssen sie vollständig entleert werden.

Wenn die Dusche blieb im Freien während der Winterperiode montiert ist es auch vom Wetter empfiehlt es mit einer geeigneten Abdeckung zu schützen, um es zu bewahren.

3.2 WARTUNGSAUSRÜSTUNG

saubere Dusche

Zum Reinigen ist es ausreichend, Wasser und Seife (Waschmittel für den Hausgebrauch) mit Tüchern nicht rau, zu verwenden Abstumpfung des Stahlrohrs zu vermeiden.

Der Hersteller übernimmt keine Haftung für Schäden aufgrund der möglichen Verwendung von Anti-Lösungsmittel, Säuren oder Alkohol.

3.3 CARTRIDGE BUTTON TIMED

(XXXX-P-Modelle)

Cartridge-Taste

Ersatzteile:

130-0120



passend für:



3 - Entfernen Sie die Taste und die Feder



4 - Entfernen der inneren Ringmutter



5 - Nehmen Sie die Patrone



6 - Entfernen und Ersetzen der Patrone

WICHTIG

Die Lieferzeit beträgt ca. 15 , kann aber auch höher sein, wenn es einen Druck von weniger als 2 atm und niedriger, wenn es einen Druck, der höher als 4 atm ist.

Der Innenring angebracht werden kann, entweder in der Standard-Position befindet, in der umgekehrten Position: in diesem zweiten Fall gibt es eine Verringerung von etwa 5 „der Dosierzeit:



7 - Ring in der Standardposition



8 - Ring in der umgekehrten Position

WICHTIG

- Wenn das Speisewasser enthält Verunreinigungen, ist es wichtig, einen geeigneten Filter zu installieren
- Für einen ordnungsgemäßen Betrieb der empfohlene Druck aus 2 4 bar



3 - FÜR DEN USER

3.4 Mischwasserkartusche (XXXX-M-Modelle)

Ersatzkartusche Code:
130-0191



passend für:



11 - Mischer montiert



12 - Lösen der
Schraube des Griffs



13 - der Griff



14 - Lösen der Ring
verchromte deckel nut



15 - Lösen der
Messingmutter



16 - die Patrone
entfernen

3.5 CONVENTIONAL GARANTIE

Die Duschen sind vom Hersteller gegen Defekte oder Fabrikationsfehler garantiert, entsprechend den geltenden Richtlinien, unter Ausschluss von natürlichen Veränderungen des Materials für die ständige Exposition gegenüber der Sonne.

Der Käufer geltend machen kann gegenüber dem Verkäufer das Recht, im Rahmen der Garantie auf Reparatur oder Ersatz für einen Zeitraum von:

- 24 Monate ab dem Datum der Lieferung und / oder Kauf, wenn der Käufer eine natürliche Person zu Zwecken handelt, die nicht in den Anwendungsbereich ihrer gewerblichen und beruflichen Tätigkeiten (Richtlinie 99/44 / EWG und ihrer Durchführungsverordnung DL 2. Februar 2002 sind, n . 24)
- 12 Monate ab dem Datum der Lieferung und / oder Kaufs, in allen anderen Fällen nicht nach Absatz 1 (Art. 1591 cc)

Das Kaufdatum muss zwingend durch eine Steuerbeleg (Quittung oder Rechnung) zertifiziert werden.

Diese Standard-Garantie hat keine Auswirkungen auf Rechte im Rahmen der genannten Richtlinie 99 / 44CEE und schließt nicht aus oder die Rechte von anderen Rechtsordnung Standards des Landes Nutzungs Ableitung begrenzen.

Ebenfalls ausgeschlossen sie von der Garantie Verschlechterung oder Veränderung des Produkts oder dessen bestimmte Elemente aus anderen Ursachen, wie zum Beispiel:

- a) fehlerhafte Montage nicht ordnungsgemäße Wartung oder das Fehlen (ein Druck höher als der maximal zulässige Druck verwenden) davon
- b) Manipulationen durch unberechtigte Personen und / oder qualifiziert
- c) Verwendung des Produkts mit verschiedenen anderen Zwecken als die, für die es entworfen wurde (Verwendung von anderer Substanz als Wasser)
- d) durch größere oder katastrophale Ereignisse (Frostfestigkeit, Feuer, Überschwemmungen, Blitzschlag, Vandalismus, etc ...)
- e) Transport und / oder unsachgemäße Lagerung
- f) Jeder Faktor oder fremd Phänomen zu den normalen Bedingungen der Verwendung und dem Betrieb des Gerätes (Bildung von Ablagerungen oder Schlamm, abnormen Korrosion, Aggression oder Acidität des Wassers, auch wenn die aus den gleichen Behandlungen, Entzundern oder Behandlungen der Reinigung nicht ordnungsgemäß durchgeführt wird)
- g) Verwendung von Ersatzteilen, Komponenten und Zubehör, die nicht original

Auf jeden Fall garantiert Es ist nur für den ursprünglichen Käufer gilt und nicht Halterung Ersatz umfassen.

Bin der Hersteller versuchen, und zu erkennen, dass das Produkt oder eine seiner Komponenten ein defektes Material hat, nach eigenem Ermessen, repariert oder es kostenlos ersetzen. In beiden Fällen wird es die Kontinuität der ursprünglichen Garantie gegeben werden.

ATI DI MARIANI SRL

Via E. Mattei, 461 - Zona Ind. Torre del Moro n°4

47522 Cesena (FC) - ITALIA

Tel. 0547 609711 Fax 0547 609724

web: www.atimariani.it - email: info@atimariani.it



Il costruttore non assume responsabilità per eventuali errori o inesattezze nel contenuto del presente libretto, e si riserva il diritto di apportare ai suoi prodotti, in qualunque momento e senza preavviso, modifiche ritenute opportune per migliorie tecniche o esigenze commerciali, nel costante perseguimento della qualità



The manufacturer is not responsible for mistakes or inaccuracy in this booklet. It also reserves the right to change its models (in any time and without any prior notice) due to technical or marketing needing, in order to pursue the quality of its products.



Der Hersteller übernimmt keine Verantwortung für Fehler oder Ungenauigkeiten in den Inhalt dieser Broschüre, und behält sich das Recht vor, seine Produkte jederzeit und ohne vorherige Ankündigung zu machen, alle erforderlichen Änderungen für technische Verbesserungen oder gewerblichen Bedarf, im ständigen Streben nach Qualität

Cesena 01/03/2015
Mario Mariani
Presidente