

# Indoor Heater

## (Baseboard Heater)

### OWNER MANUAL

Model: JH-NC18-18C  
JH-NC20-18C  
JH-NC22-18C

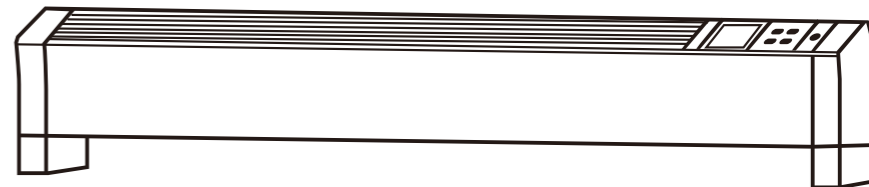

#### 220V special-purpose products

Thanks for buying our products, please read the owner manual before use.  
Please use it correctly after understanding the function.  
Please take care of the manual.





In order to keep safe, please make sure to check the product per 1-2 year regularly,  
even if there is no problem during use. In this case, it can be used for longer, safer  
and more convenient.

(please take the actual product as the standard)

## Safety Precautions

Note: All contents are related to safety, please follow.



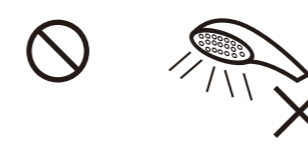



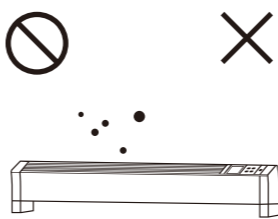
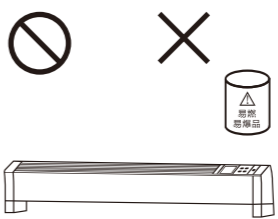
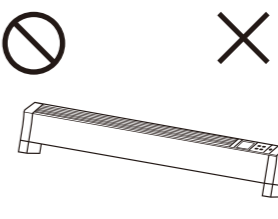
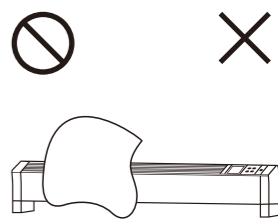
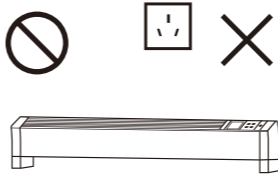
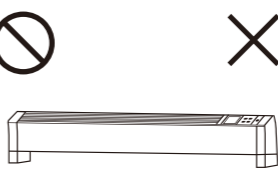
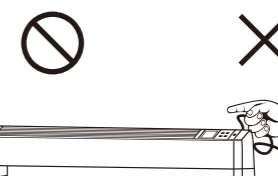
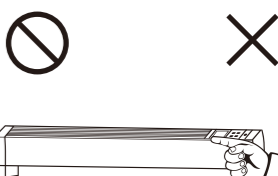





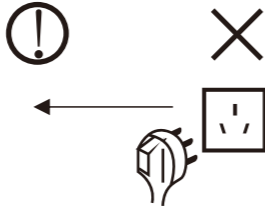

1. Please do not use other accessories that are not approved by the manufacturer.
2. Please check if the heater is in good condition when you get it and check if all the accessories are complete.
3. If the power cord is damaged, it must be replaced by a professional from the manufacturer, its service department or similar department in order to avoid danger.
4. Children and incapacitated persons should use the heater under the supervision of the guardian.
5. In the event of a malfunction, Please immediately unplug the power supply and do not place the defective product in operation.

 Prohibitory Sign	<p>Anything with this mark is an act that must be prohibited, otherwise it may cause damage to the product or endanger user's safety.</p>
 Warning Sign	<p>Anything with this mark must be operated in strict accordance with the requirements, otherwise it may cause damage to the product or endanger user's safety.</p>
 Attention Sign	<p>Anything with this mark is the part that the user must pay attention to, otherwise it will cause damage to the product or cause other losses due to improper creation.</p>
 <p>This product is an indoor heater and is prohibited to be used in outdoor.</p>	 <p>Do not use the heater around bathtubs, showers or swimming pools.</p>

## Safety Precautions

 <p>Do not use the heater in environments with severe dust.</p>	 <p>It is prohibited to store flammable, explosive or heat-deformable and deteriorating items near the heater.</p>	 <p>Do not tip over or tilt the heater.</p>	 <p>Warning: To avoid overheating, do not cover the heater.</p>
 <p>Do not place the heater directly under the power socket.</p>	 <p>Do not use the program, timer or any other device with an automatically connectable power supply.</p>	 <p>Do not pull the heater with power wires when it is at work.</p>	 <p>Do not touch the surface of the air outlet when the heater is at work.</p>

## Safety Precautions

  <p>Avoid sharing sockets with other high power consumption appliances</p>	  <p>Power cord should be placed on the back of the heater</p>	 <p>The heater should be operated by power switch instead of power plug</p>	  <p>It is normal to hear some sounds after heater is on/off due to thermal expansion and contraction of heating components.</p>
  <p>It is normal if a small amount of white smoke and odor appear when first used.</p>	  <p>Do not bend, pull, or entangle the power cord.</p>	  <p>Do not disassemble the heater or modify the product to avoid danger.</p>	  <p>Please unplug the heater When it's out of use for a long time.</p>

## Features:

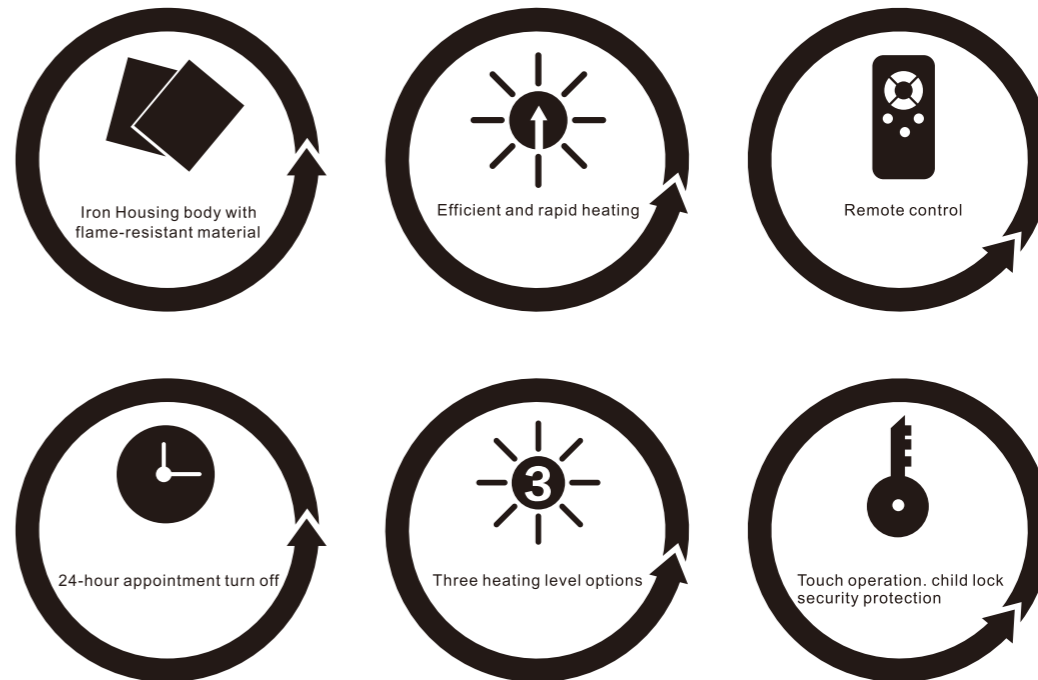

## Spare Parts and Parameter

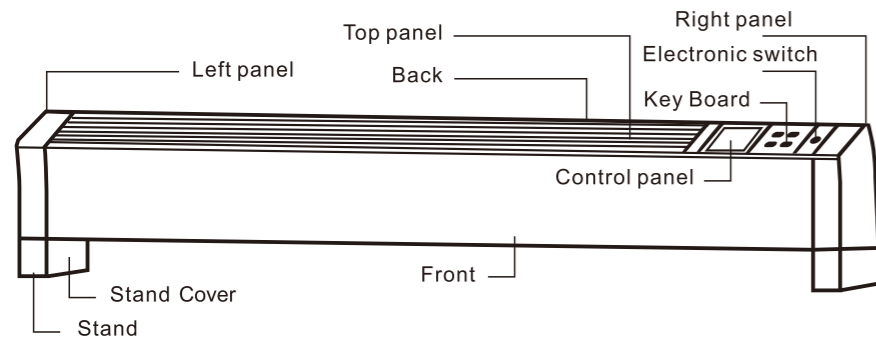

Model	Rated Voltage	Rated Frequency	Rated Current
JH-NC18-18C	220V	50Hz	1800W
JH-NC20-18C	220V	50Hz	2000W
JH-NC22-18C	220V	50Hz	2200W

## Circuit diagram

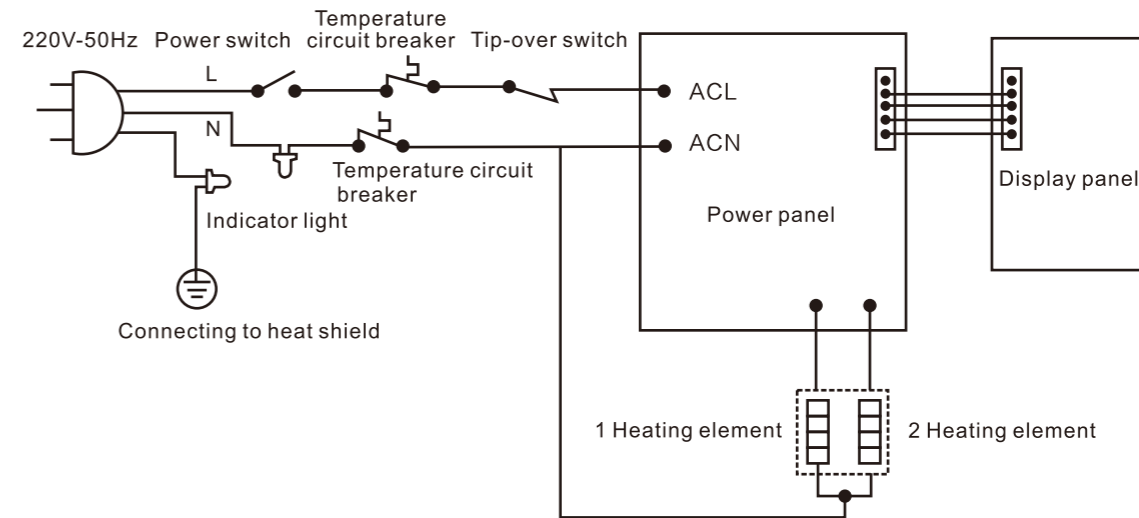

## Installation

1. Open the package, take out the heater. Make sure it's in good condition.
2. A. Floor stand  
Put down the heater, insert the stand to the bottom and check the balance.  
B. Wall mounted
  - a. Make two holes on the wall.(the height should not be higher than 300mm or lower than 150mm).
  - b. Screw the staple plug and screw in the holes, and keep 5mm outside the wall.
  - c. Hang up the heater (without the stand) by its rear holes.
3. Plug in (AC 220V/50Hz).
4. Turn on the power, gently press the key spot to select corresponding functions.

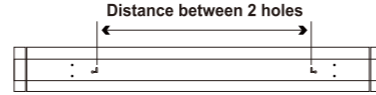

Model	Distance between 2 holes
JH-NC18-18C	663.7mm
JH-NC20-18C	663.7mm
JH-NC22-18C	850.3mm

## Remote

1. Remote controller shares the same function with control panel.
2. Best distance for the remote control: within 5 meters  
Best control angle: 30 degrees, left to right.
3. Avoid sunlight to influence the communication between remote and heater.
4. Take out the batteries when they are not in service in certain period or when batteries' power off. Please obey the law when dispose the batteries.
5. Remote controller shall with 2 pcs 1.5V batteries.
6. Make sure batteries are correct installed.

## Heater

1. Make sure it's under AC 220V(±15%) condition.Current should over 10A when power consumption is under 2200W.Current should over 15A when power consumption is over 2200W.
2. You will hear a “Di” sound when power is on, and then the power indicator---light will turn on. That's the standby mood. On the contrary, the light will turn off when power is shut down.
3. Control panel
  - A. ON/OFF  
By pressing this button, you can turn on and off heater. Heater starts at level 1<sup>st</sup> and temperature on 25°C. It stops heating when ambient temperature is over or equals to 25°C. By adjusting temperature setting program, you can get more heat. In order to keep heating, temperature should be set higher than ambient temperature.
  - B. Power  
The heater has three-level temperature setting, low, medium, and high. By pressing this button, you can set the temperature sequentially.
  - C. Timer  
By pressing this button, you can gradually set the timer from 1 hour to 24 hours, 1 hour per time.
  - D. T. + & T. -  
By pressing these buttons, you can easily set the temperature program up and down.
  - E. Lock  
By pressing this button, you can lock up all the functions when the heater is on. Keep pressing this button more than 3 seconds and press any lock button on the remote, the lock program will be unlocked.

### Cleaning and maintenance

- 1.Plug off before cleaning and maintenance, confirm plug is off from socket and heater is cool down.
- 2.Do not wash heater directly, use soft cloth with neutral detergent to wipe gently, and then wipe dry. Do not use any liquid, for example gasoline.
- 3.Please use heater or pack heater after heater is totally dry.
- 4.If it's out of use for a long time , please clean heater and pack it in the box after totally dry, and then store in a dry place.

### Malfunction Diagnosis

Check the following points before entrusting maintenance department

Malfunction	Possible reason	Solution
Not hot after power on for 3 minutes	Improperly plug in	Plug in correctly
	The switch is not turn on	Turn on switch
	The floor is uneven	put heater on even floor or table

If there are other malfunctions, please contact with after-sale service center for help.

### Declaration of restricted substances

The table is according to SJ/T 11364 《Requirements of use identity on Restrictions of harmful substances in electronic and electrical products》 and GB/T 26572 《Limited quantity requirements for restricted substances in electronic and electrical products》, declaration of our heater on restricted substances content.



This table is according to SJ/T 11364:  
 O: means restricted substances content is less than the standard of GB/T 26572  
 X: means restricted substances content is over the limit requirement of standard GB/T 26572

Spare parts	Name: Indoor heater (Baseboard heater)					
	restricted substances					
	Pb	Hg	Cd	Cr	PBB	PBDE
Front	○	○	○	×	○	×
Back	○	○	○	×	○	×
switch	○	○	○	○	×	×
Stand	○	○	○	○	○	×
control box	○	○	○	○	○	×
control board	○	○	○	×	○	○
heating element	○	○	○	×	○	○
inside wiring	○	○	○	○	○	○
power switch	○	○	○	○	○	○
Over-heat protection	×	○	×	○	○	○
Power cord	○	○	○	○	×	×
screw and nut	○	○	○	×	○	○
owner manual	○	○	○	○	○	○
labeling	○	○	○	○	○	○
carton box	○	○	○	○	○	○