

**IMPORTANT:** It is important to read these instructions carefully before using the appliance for the first time. Keep the instructions safe so that you can refer to them later if necessary



## Sined Wall-mounted Electric Fireplaces - User Manual



Models :

**CAMINETTO-PARETE-BIANCO**  
**CAMINETTO-PARETE-STELVIO**  
**CAMINETTO-PARETE-APRICA**  
**CAMINETTO-PARETE-PORDOI**

This appliance is intended to be used in household and similar applications such as:

- staff kitchen areas in shops, offices and other working environments,
- farm houses,
- by clients in hotels, motels and other residential type environment,-
- bed and breakfast type environment
- areas for communal use in blocks or flats or in launderettes

**WARNING:**

1. In avoid to overheating, do not cover the fireplace.
2. Do not use this heater in the immediate surroundings of a bath, a shower or a swimming pool..
3. Do not use this heater if it has been dropped.
4. Do not use if there are visible signs of damage to the heater. The heater must not be used if the glass panels are damaged.
5. Use this heater on a horizontal and stable surface, or fix it to the wall, as applicable.
6. Do not use this heater in small rooms when they are occupied by persons not capable leaving the room on their own, unless constant supervision is provided.
7. Extreme caution is necessary when children are near the fireplace and whenever the fireplace is left operating and unattended.
8. Always unplug fireplace when not in use.
9. Do not operate the fireplace with a damaged cord or plug or after the heater malfunctions, has been dropped or damaged in any manner, return heater to authorized service facility for examination, electrical or mechanical adjustment, or repair.
10. Do not use outdoors. It's only suitable for indoor use.
11. Do not run cord under carpeting. Do not cover cord with throw rugs, runners, or similar coverings. Arrange cord away from traffic area and where it will not be tipped over.
12. To disconnect fireplace, turn controls to off, then remove plug from outlet.
13. Do not inset or allow foreign objects to enter any ventilation or exhaust opening as this may cause an electric shock or fire, or damage the fireplace.
14. To prevent a possible fire, do not block air intakes or exhaust in any manner. Do not use on soft surfaces, like a bed, where openings may become blocked.
15. It has hot and arcing or sparking parts inside. Do not use it in areas where gasoline, or flammable liquids are used or stored.
16. Use this fireplace only as describes in this manual. Any other use not recommended by the manufacturer may cause fire, electric shock, or injury to persons.
17. DANGER-HIGH Temperatures may be generated under certain abnormal conditions. Do not partially or fully cover or obstruct the front of the heater.
18. Do not use this heater with a programmer, timer, independent remote-control system, or any other device that automatically turns on the heater, because if the heater is covered or incorrectly positioned, there is a risk of fire.
19. Do not use the Electric fireplace for any other purposes than those described in this instruction manual.
20. This appliance is not intended for use by persons (including children) with

reduced physical, sensory or mental capabilities, or lack of experience and knowledge, unless they have been given supervision or instruction concerning use of the appliance by a person responsible for their safety.

21. Children should be supervised to ensure that they do not play with the appliance.

22. Do not use this appliance outdoors.

23. Always unplug the Electric fireplace from the power supply when not in use and before cleaning.

24. To protect against the risk of electric shock, do not immerse the appliance in water or in any other liquids.

25. Components should only be serviced by an approved electro technician.

26. "If the supply cord is damaged, it must be replaced by the manufacturer, its service agent or similarly qualified persons in order to avoid a hazard."

### **Cleaning the exterior of the appliance**

Before cleaning the appliance, disconnect it from the socket and leave to cool.

Do not use cleaning or polishing products.

**CAUTION:** In order to avoid a hazard due to inadvertent resetting of the thermal cut-out, this appliance must not be supplied through an external switching device, such as a timer, or connected to a circuit that is regularly switched on and off by the utility.

## Unpacking Operation

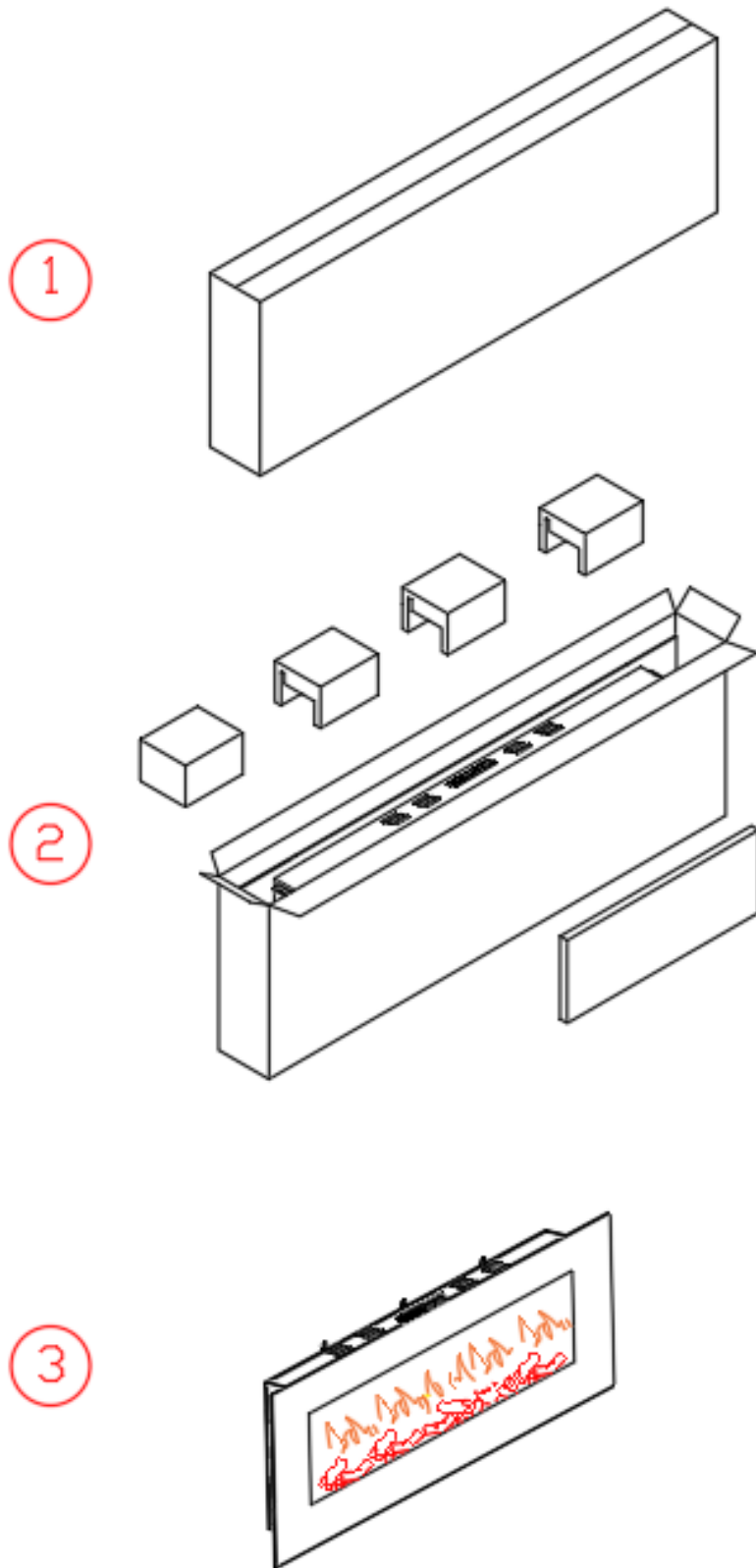

The product must be handled with care to avoid breaking the glass, we recommend placing the fireplace on a carpet during assembly and not directly on the floor

### Shape and dimensions (mm)

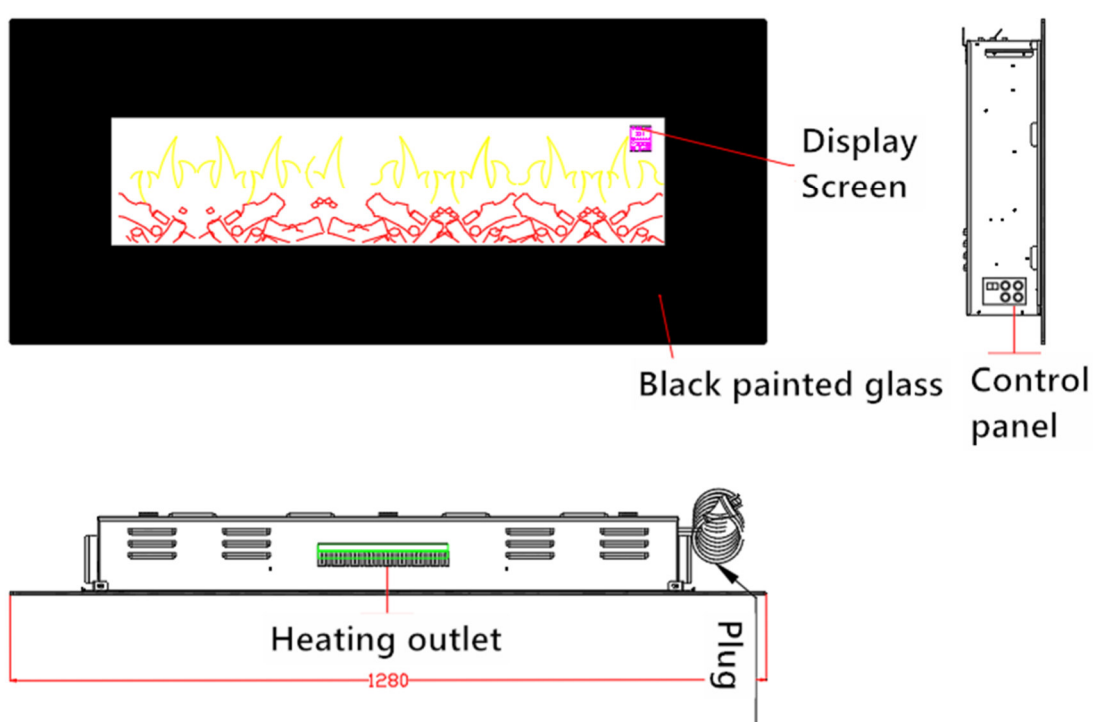

Product size list (mm)			
Model	Length	Height	Depth
CAMINETTO-PARETE-BIANCO	980	550	138
CAMINETTO-PARETE-STELVIO	1280	550	138
CAMINETTO-PARETE-APRICA	1520	550	138
CAMINETTO-PARETE-PORDOI	1830	550	138

## Installation Instructions

Check the position of the dowel holes in the wall to which the hearth is to be fixed, it is the responsibility of the installer to use dowels suitable for the type of wall and the weight of the hearth if necessary use dowels other than those supplied.

**Note:** The supporting wall must be flat, complete and solid. The power cable must be plugged into an earthed socket.

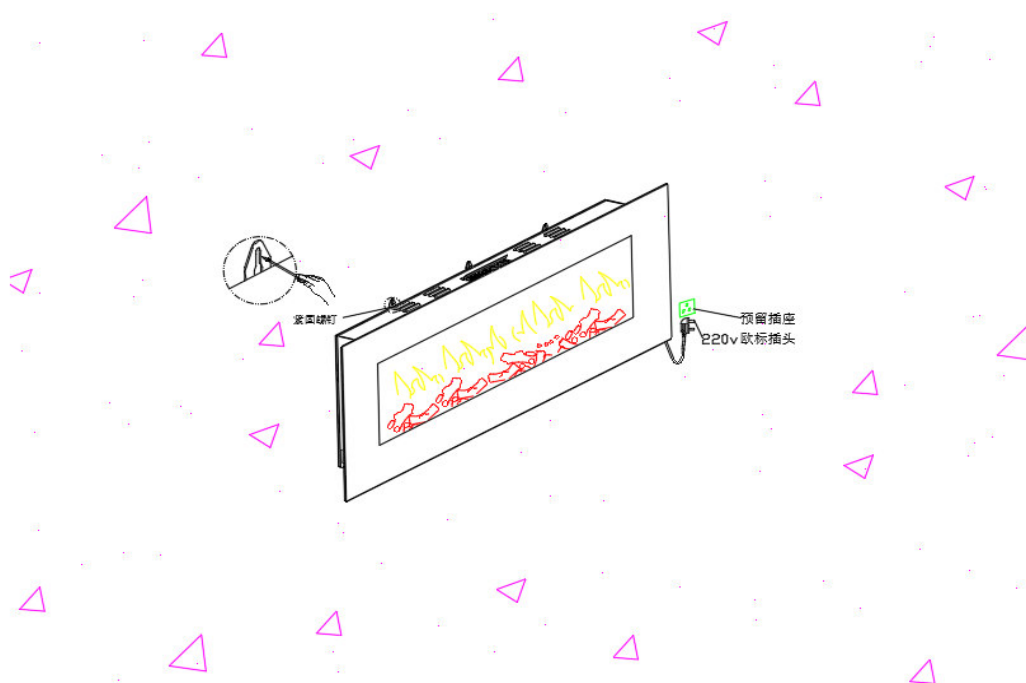

## Anterior functional area:

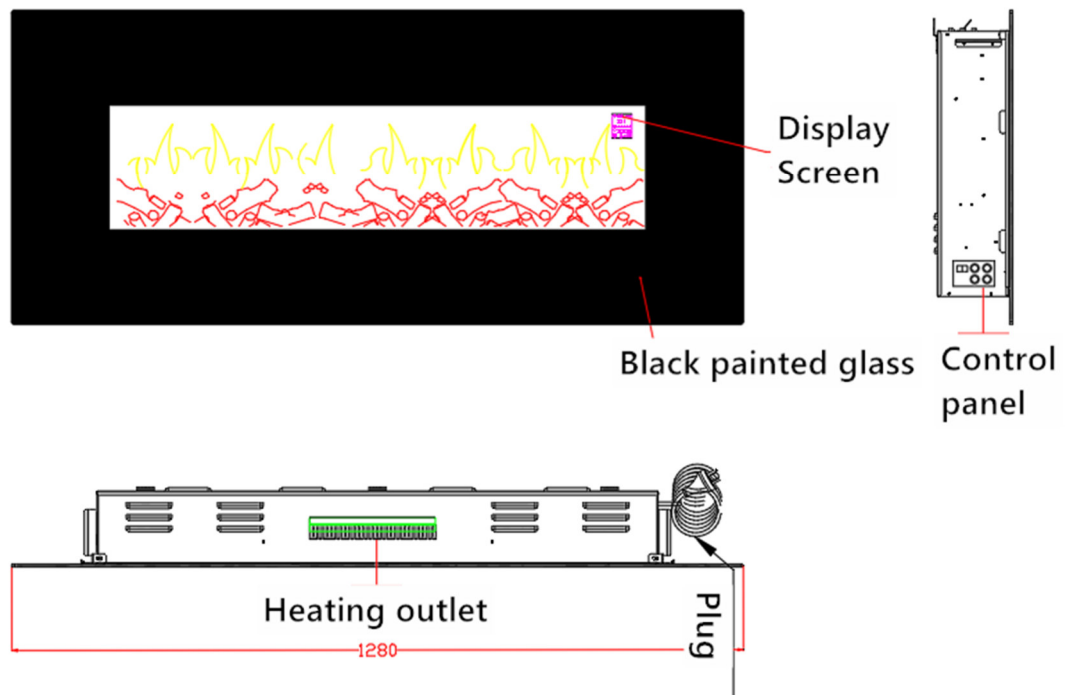

**Attention:** this fireplace model is designed to be hung on a wall, it is not a built-in model!

**If you require a model to be embedded in a wall** or cabinet we have specially designed and tested models available

**Safety tip:** To avoid fire, do not place anything within 100 mm above the upper hot air outlet grille

Configuration Information	
Product Name	Electric Fireplace
Operation mode	Manual/Remote control
Rated Voltage	220-240V~
Rated Frequency:	50/60Hz
Viewing Power	10W-300W
Rated Power	High:1500W; Low: 750W
Basic	Infrared remote control
	Manual key
	Adjustable flame
	Heating function
	Single-color flame
Optional	Multi-color flame
	Crystal
	Cobblestone
	DIY fake log
Safety Certification	CE RoHS
Attachments	Remote control
	Manual
	Warranty card





This product has been tested in a special electrical room according to national standards. If you need help during use, please contact us in time.

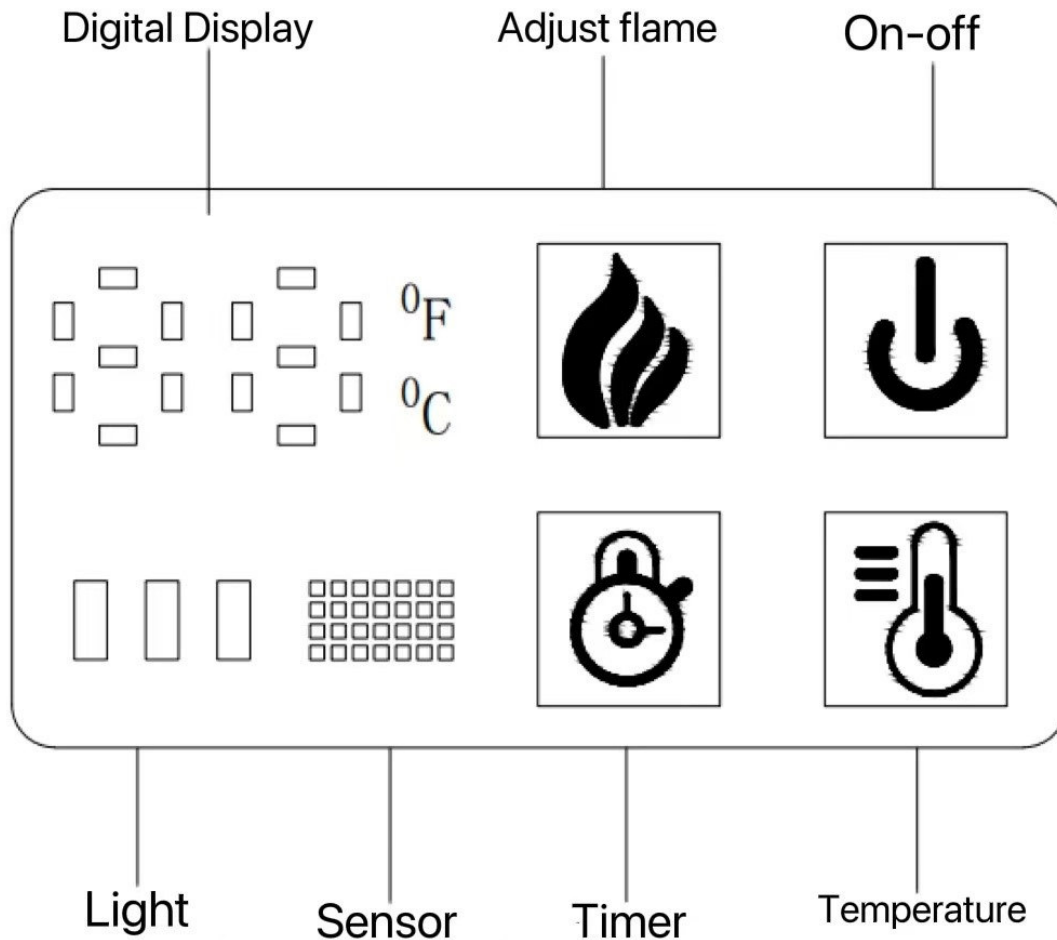

## Manual button operation



## Manual button operation

Symbol	Name	Description
	On-off	Turn on/off the machine
	Temper	Adjust temperature 19-30°C
	Timer	Timing: 30min-1h-2h-3h-4h-5h-6h-7h-8h-30min
	Flame	1-6 levels flame

## Remote Control Functions

### Symbols on Remote Control

-  — On/Off
-  — Flame brightness
-  — Heater
-  — Temperature rises
-  — Temperature reduces
-  — Timer
-  — **No function**
-  — Hour timer
-  — Minutes timer
-  — Day timer
-  — Week timer
-  — On/ Off week timer
-  — **No function**
-  — **No function**

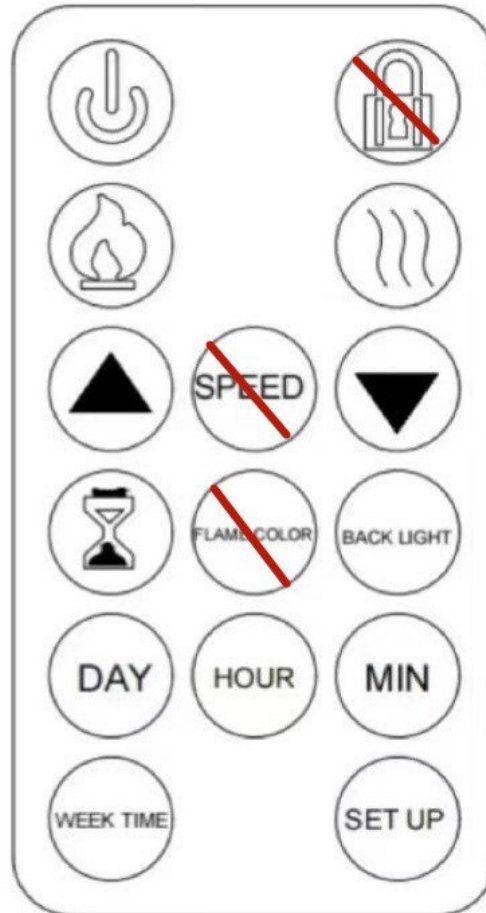

Attention: Remote control buttons with crossed out symbols \ are not active in these models

# Digital control screen in the fireplace

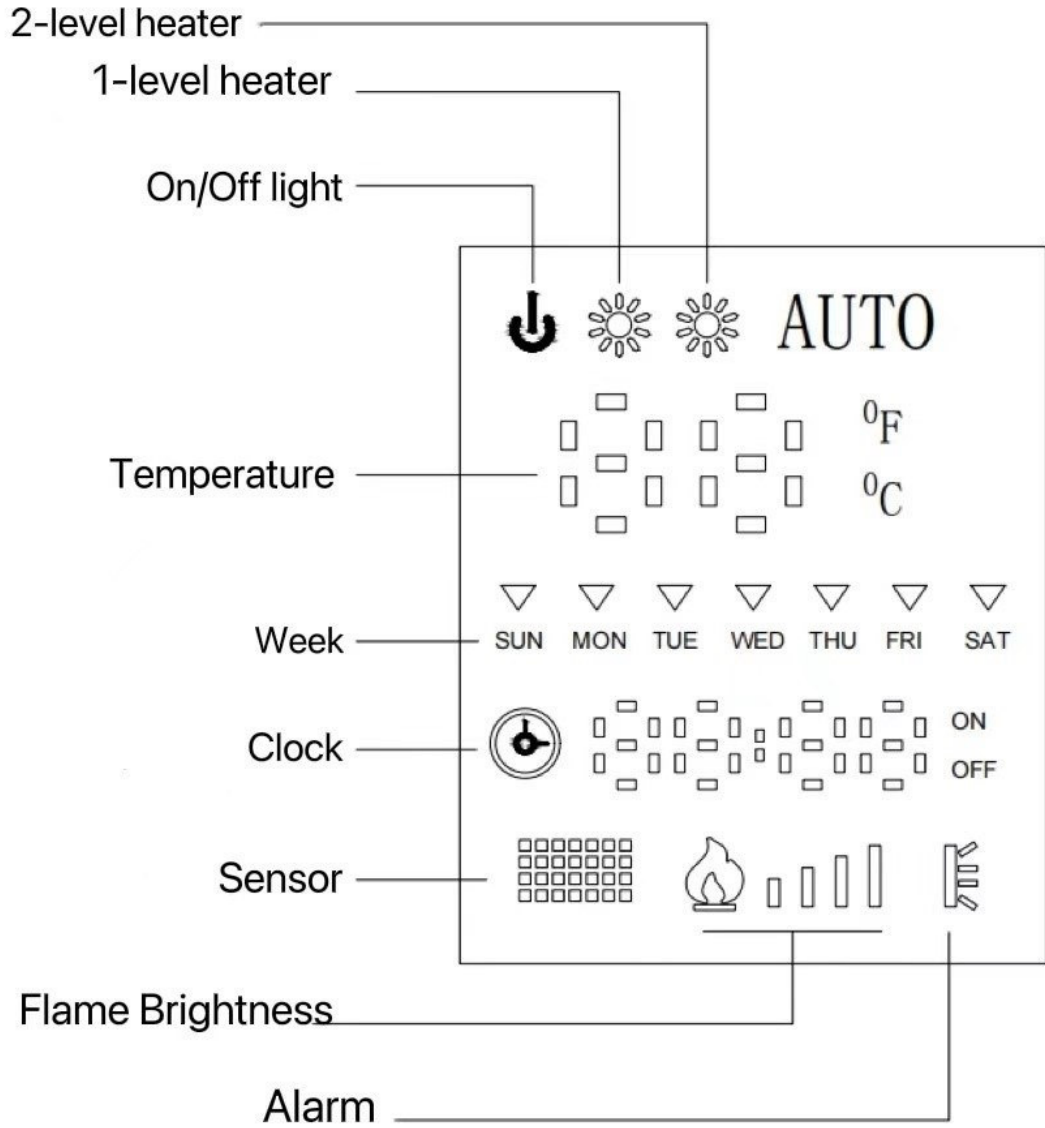

## Remote Control Operation



On/Off

Press this button to turn on with F1 on screen. Press this button to turn off with nothing on screen.



This button no function



Adjust flame brightness

Default F1. F1-F2-F3-F4-F5-F6-F1. The number corresponds to flame brightness.

Display	F1	F2	F3	F4	F5	F6
Set	1	2	3	4	5	6
Brightness	100%	80%	60%	40%	20%	0%



Heater (Be off by default)

1."LL" 1-level heater with one icon 

2."HH" 2-level heater with two icons 



Temperature rises

The default startup temperature is 19°C. Short press to rise one degree.

Temperature cycle: 19-30°C(66-68°F). Long press for 5 seconds to convert temperature units. C(F) can be turned off for heating.



Temperature reduces

Short press to reduce 1 degree. Rising to a certain temperature, it will turn off the heating when it rises by 1 degree. Reducing to a certain temperature, it will turn on the heating when it reduces by 2 degrees.



## Timer

It's disabled by default. Short pressing will adjust the timer range from 30Min-1H-2H-3H-4H-5H-6H-7H-8H-30Min. The symbol light is on by default.



This button no function



Day timer

There is a timing function. When turning on the fireplace, the timer icon light will be on. The clock will show 00:00. The week icon light will be on and show SUN.

When the timer is needed after turning on, press "DAY" button on remote control. Each time you press the button, the week icon light will be on from left to right to set the time to the current date.



Hour timer

Each time you press the "HOUR" button, the time is increased by one hour. Set the time to the current hour, hour timer scope is: 00-23.



Minutes timer

Each time you press the "MIN" button, the time is increased by one minute. Set the time to the current minutes, minutes timer scope is: 00-59.

When it is not unplugged or disconnected, the on-off time will have memory function, which will not be reset. If unusual timer id discovered, the batteries powering the mainboard may be dead. Please replace the batteries quickly. (Battery Model: CR1220-3V), (Each time you press the button, the buzzer will make a short sound.)



## Week timer

It has a week timing switch function.

1. First press "WEEK TIME" button, the week icon will turn the current time to SUN(Sunday) and flash. The icon of clock and ON will flash at the same time.
2. Set the startup time of the day. Press "HOUR" button to set starting up hour, press "MIN" button to set starting up minutes. (Each time you press the button, the number will increase 1.) Then press "SET UP" button to confirm. ON light will be off and OFF light will be on.
3. Set the off time of the day, the process is the same with setting the startup time. After setting for one day, press "WEEK TIME" again to set for another day.
4. If you don't operate the week timer during the week display flashes for ten seconds, the clock on the digital screen will be always on. The light of ON/OFF will be off. (Each time you short press the button, the buzzer will make a short sound.)



## On/Off week timer

Press the button to turn on/off the week timer function.



## Alarm

1. Electric fireplace has window opening detection function. When it is in heating state and detects a temperature drop of 3 degrees within 5 minutes, it will turn of heating function automatically. Buzzer will make a long sound three times. The alarm icon light will flash to remind the user that the window has been opened.
2. After the alarm is on, press the heater or temperature button to clear

alarm reminder.



This button has No function

Troubleshooting		
Symptom	Probable Causes	Solution
Not Work	Poor contact between plug and socket	Connect the plug correctly or change it
	Power is off	Turn on
	Protector overheats	Turn off power, natural cooling for 15min.
	Protector overheats and burned out	After-sale repairing
Heating without flames	Lights damage	After-sale repairing
Flames without heating	Heater is off	Turn on heater
Remote control not responding	Misaligned infrared reception	Adjust angles and distance
	An internal fuse has blown	After-sale repairing
Flames with noise	Spark shaft is falling	Contact the after-sales service.
Part of the flame is not bright	The lamp strip socket is loose or falls off	After-sale repairing

### Caution

Please cut off the power before the maintenance of the appliance.

Workers with maintenance qualification are required to avoid accidents and personal injury.

### Final Interpretation

The final interpretation right is of our company. Please know if the product appearance and structure are changed, there is no need to inform the user.

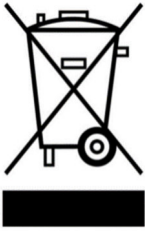

### **Correct Disposal of this product**

This marking indicates that this product should not be disposed with other household wastes throughout the EU. To prevent possible harm to the environment or human health from uncontrolled waste disposal, recycle it responsibly to promote the sustainable reuse of material resources. To return your used device, please use the return and collection systems or contact the retailer where the product was purchased. They can take this product for environmental safe, recycling.

Production: Suzhou Yueyu Thermal Energy Technology Co.  
Indirizzo della fabbrica: No. 6 Xinghai Road, Liuhe, Taicang, Taicang City, Città di Suzhou, provincia di Jiangsu, Cina

Made in China

Imported into Italy by M.P.C. srl Via Tortona 20144 Milano Italia Tel +39 02 21117815 e-mail [info@mpcshop.it](mailto:info@mpcshop.it) sito web

[www.sinedtechnology.com](http://www.sinedtechnology.com)

The SINED trademark and the SINED logo are registered by Sined Ventas Online S.L.U. EUTM 018196373