

GARDEN FOUNTAIN-WATER

FOUNTAIN-WATER-WHITE

Instructions for Use and Maintenance



The photo is only indicative. The actual product may appear slightly different in colour.

Thank you for purchasing this SINED product. We are constantly improving our products. However, should this product have any defects, we apologise and please contact our customer service.

USER AND MAINTENANCE MANUAL

- This manual is an integral part of the purchased product. It contains important information for the installation and use of the product. Before using the product, read the instructions carefully, especially the safety warnings. Failure to follow the instructions and warnings can result in serious personal injury and damage to the product. The instructions provided are based on the rules and regulations valid in the European Union. For other countries, follow the specific regulations. Keep the instructions for future reference and pass them on to third parties.

INTENDED USE

- **This garden fountain model is recommended for family use.**
- A garden fountain is designed to be used exclusively outdoors or on a terrace. The fountain only dispenses cold water that can be used for watering or rinsing hands and feet and is NOT drinking water. Only use the product as described in the instructions. Any other use may cause damage to property or even people. This product is not a toy. The manufacturer or seller accepts no liability for any damage resulting from incorrect or improper use.
- **Safety Warnings**
- Read carefully and comply with all warnings and instructions. Failure to observe them may result in property damage, serious personal injury or even death. These product safety warnings, instructions and provisions cover many but not all possible hazards and risks. Please pay attention to and correctly assess all hazardous situations. Improper use of the product could also be life-threatening.
- **Caution!** Any repair work should only be carried out by qualified personnel in order to avoid possible hazards. If necessary, contact a qualified technician. In the event of self-performed repairs, improper assembly or incorrect use, liability and warranty claims are forfeited. Only spare parts that correspond to the original product data may be used for repairs.

WARNING! Dangers to children and persons with reduced physical, sensory or mental capabilities or lack of experience and knowledge: Children must not play with this product. Cleaning must not be carried out by children or persons with reduced physical, sensory or mental capabilities.

NOTE: Risk of damage! The product can be damaged by improper use.

- **Checking the contents**
- **WARNING!** Risk of damage to the product! If the packaging is opened without due care using a sharp knife or other sharp tools, the contents may be damaged. When opening the packaging, therefore, be careful to:
 - Unpack the product
 - Check the contents of the packaging
 - Check that the product and individual components are undamaged and undamaged. If this is not the case, do not use the product and contact the seller immediately.

Determine the installation position

To ensure the best possible stability and your safety, the fountain must be installed on a stable surface.
Installation must be carried out by qualified personnel.

Installation

Follow the diagrams below for installation and assembly.

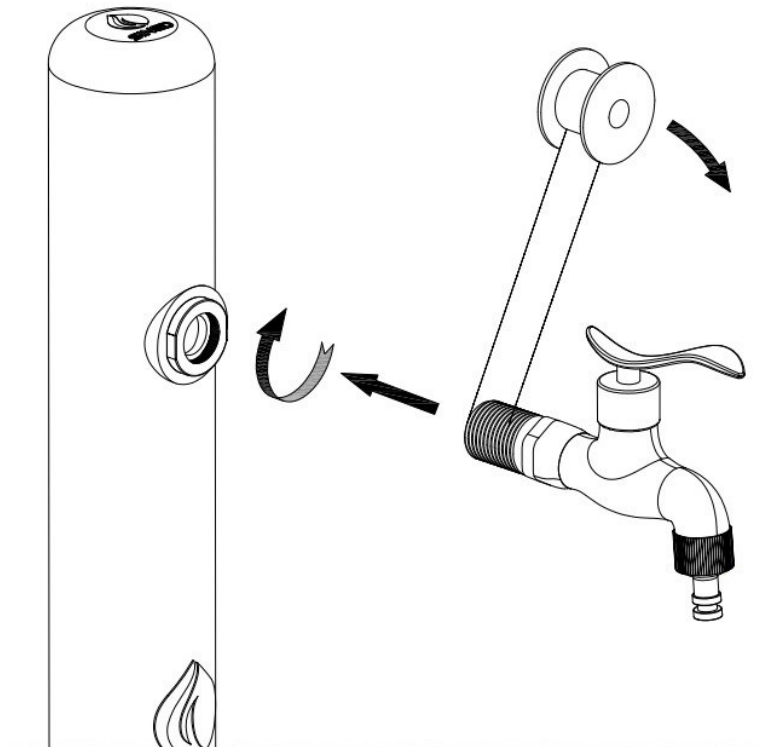

Before installing the tap, ensure that the rubber washer is correctly positioned.

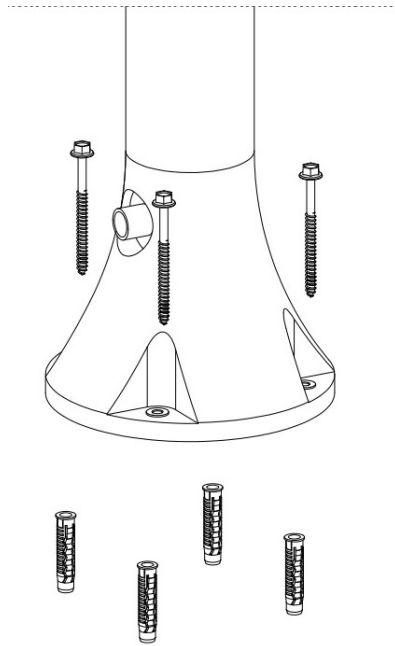

We recommend that you do not drill directly through the holes in the shower base!

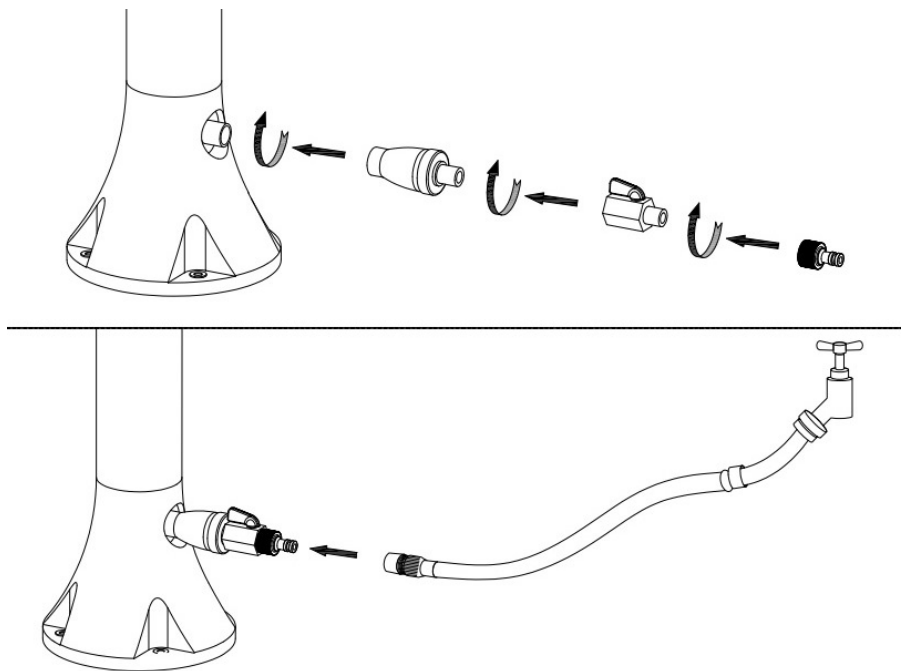

First start-up

Before connecting the water hose to the fountain, purge the pipes by running the water for at least 5 minutes to remove any debris that may be in the pipes. Make sure that only clean water without debris comes out. Smontaggio a fine stagione

During the winter period, the fountain must be COMPLETELY drained of the water it contains. Also during the winter the fountain must be dismantled and stored in a dry place.

Remove the fixing screws on the base and empty the remaining water from the bottom of the fountain by tilting it (absolutely necessary!).

Failure to observe this warning can lead to frost damage to the product.

Frost damage is not covered by warranty.

Cleaning

Use commercially available cleaning agents for cleaning. Do not use cleaning agents containing solvents, abrasive cleaners or hard sponges, brushes, etc.

Warranty

The regulations in force in the European Community apply.

The SINED fanfares have a guarantee of 2 years from the date of purchase against material and manufacturing defects.

- Excluded from the guarantee are components subject to wear and tear, including mixers, shower heads, taps, etc.
 - Damage due to incorrect assembly, improper use and incorrect maintenance (e.g. use of inappropriate cleaning agents) are not covered by the warranty.
 - Damage resulting from the use of non-original spare parts is not covered by the guarantee.
 - Damage resulting from work not carried out by specialist technicians is not covered by the warranty.
 - Damage due to frost, limescale or other impurities inside the shower is not covered by the guarantee.
- In the event of problems covered by the guarantee, the product must be returned to the seller.
- The product shall be carefully packed and complete with all parts and accessories;
 - The reason for return must be described in detail and proof of purchase (invoice or receipt) must be provided;
 - The return shipping costs shall be borne by the purchaser;
 - The returned product will be inspected at the seller's premises and repaired or replaced at the seller's sole discretion.

Manufacturing: Starmatrix Group Inc.

Address: 253 Mengxi Road

Zhenjiang, Jiangsu, CHINA

Made in China Imported into Italy by M.P.C. srl Via Tortona 21 Milano 20144 Milan Italy Tel +390221117815

e-mail info@mpcshop.it website www.sinedtechnology.com

The SINED trademark and the SINED logo are registered by SINED VENTAS ONLINE S.L.U. EUTM 018196373

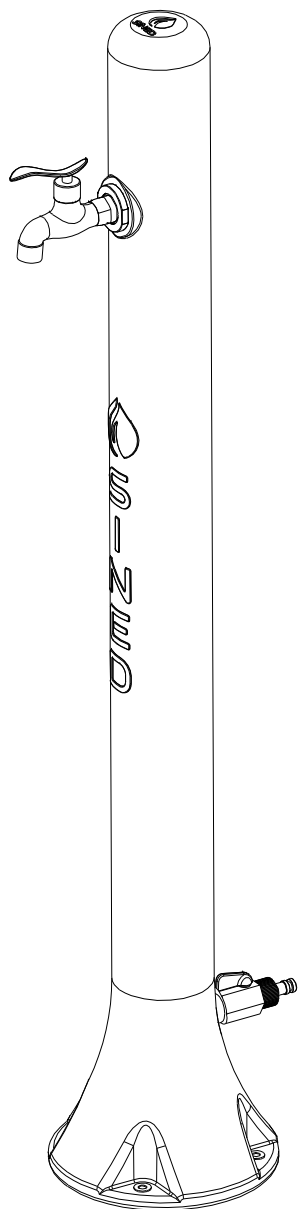

[02] x1



[03] x1



[04] x1



[05] x1



[06] x4



10mm



10mm

10mm



1



[02] x1



[03] x1

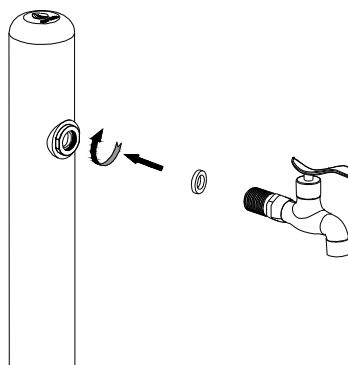

2



10mm



10mm



[06] x4

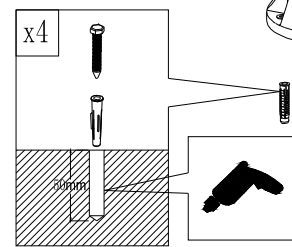

3



[04] x1



[05] x1

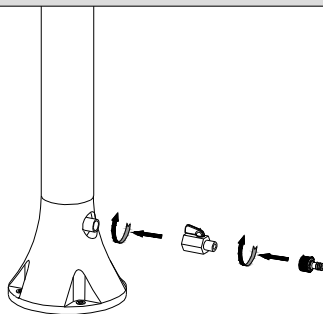

4

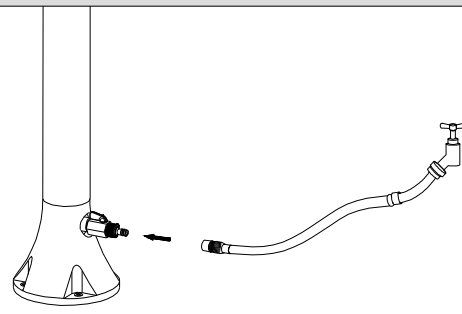

5

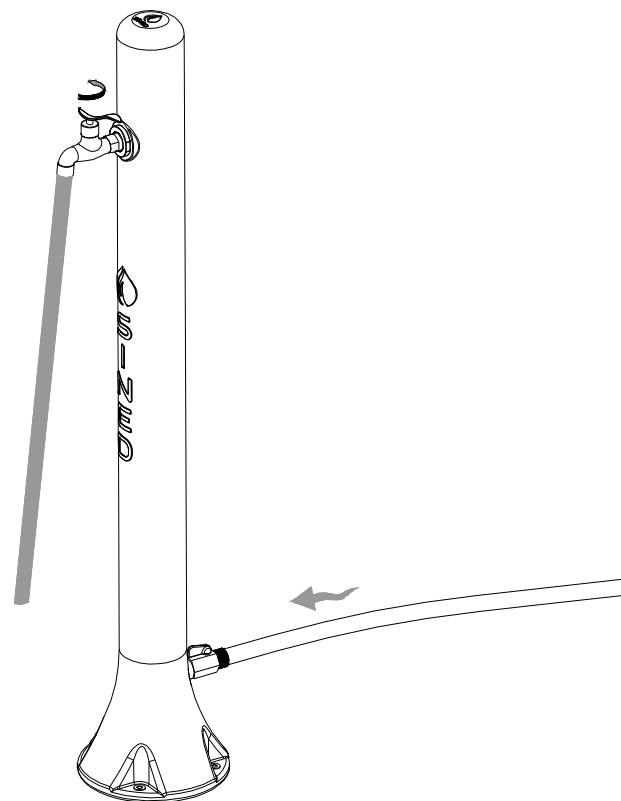

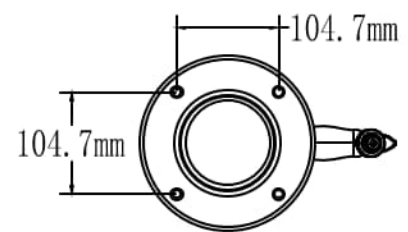
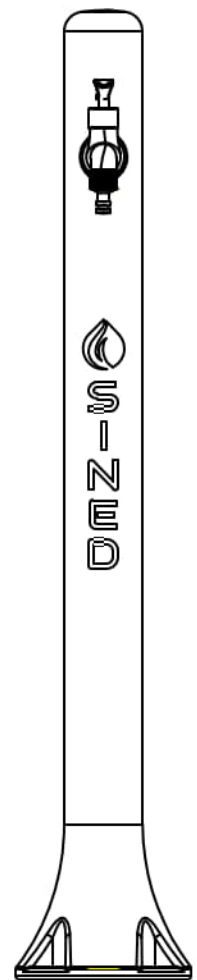
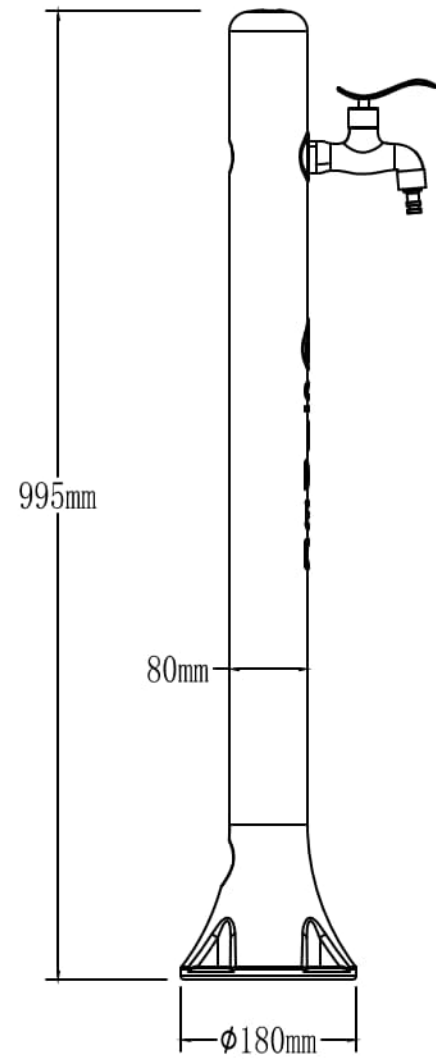

C80

